



MINUTES

Bush Fire Advisory Committee

26 September 2023

**Minutes of the Bush Fire Advisory Committee Meeting
Held at the Broomehill Recreational Complex
on 26 September 2023**

TABLE OF CONTENTS

1.	OPENING	1
2.	ATTENDANCE AND APOLOGIES	1
3.	CONFIRMATION OF PREVIOUS MEETING MINUTES	1
3.1	CONFIRMATION OF THE MINUTES OF THE COMMITTEE MEETING HELD 22 MARCH 2023	1
4.	BUSINESS ARISING FROM PREVIOUS MINUTES	1
5.	REPORTS	2
5.1	BRIGADE REPORTS	2
5.2	CHIEF BUSH FIRE CONTROL OFFICER REPORT	3
5.3	COMMUNITY EMERGENCY SERVICES MANAGER REPORT	3
5.4	DEPARTMENT OF FIRE AND EMERGENCY SERVICES REPORT	4
5.5	CHIEF EXECUTIVE OFFICER REPORT	4
5.6	RANGER REPORT	4
6.	MATTERS FOR DECISION	5
6.1	REVIEW OF BUSH FIRE BRIGADE STANDARD OPERATING PROCEDURES	5
7.	MATTERS FOR DISCUSSION/INFORMATION	7
8.	GENERAL BUSINESS	7
9.	NEXT MEETING AND CLOSE	8

This document is available in other formats on request for people with disability.

1. OPENING

The Chair, Cr White, declared the meeting open at 6.35pm.

2. ATTENDANCE AND APOLOGIES

Attendance:

Cr Michael White	Shire President (Chair)
Kim Oliver	Chief Bush Fire Control Office (CBFCO)
Michael Altus	Deputy Chief Bush Fire Control Officer (DCBFCO)
Rhys Brown	Deputy Chief Bush Fire Control Officer (DCBFCO)
Andrew Webster	Fire Control Officer (FCO) - Broomehill Central
Carl Letter	Tambellup East
Nick Bowman	Broomehill East
Laurie Hull	FCO - Tambellup Volunteer Fire & Emergency Service (VFES)
Jedd Herbert	FCO - Tambellup West
Ben Adam	Broomehill West

Observers:

Craig Beacham	Captain, Tambellup VFES
Mandy Plant	Tambellup VFES
Cindy Pearce	Community Emergency Services Manager (CESM)
Pam Hull	Shire of Broomehill-Tambellup (Minutes)

Apologies:

Anthony Middleton	CEO
Craig Dewar	Broomehill East
Chris Rumble	FCO - Tambellup East
Josh Holmes	FCO - Broomehill East
Brant Dennis	FCO - Broomehill West
Stephanie Swain	Ranger

3. CONFIRMATION OF PREVIOUS MEETING MINUTES

3.1 CONFIRMATION OF THE MINUTES OF THE COMMITTEE MEETING HELD 22 MARCH 2023

Officer Recommendation/Committee Decision

Moved Laurie Hull, seconded Rhys Brown that the Minutes of the Bush Fire Advisory Committee Meeting held on 22 March 2023 be accepted as a true and correct record.

CARRIED

4. BUSINESS ARISING FROM PREVIOUS MINUTES

The signs informing the community of the current fire season (item 7.1) have been ordered.

5. REPORTS

5.1 BRIGADE REPORTS

Broomehill Central (Andrew Webster FCO)

Fires attended by Broomehill Central Fire Brigade
May 2023

May 9th

Andrew Webster, Jon Webster and Brian Conning attended a fire at the property 'Estosia Meadows'

We took the town fire truck and got a small fire under control quickly.

Fire had started on the property but travelled into crown land.

Only a couple of hectares burnt mainly grass and a few trees came down

Assistance was provided from David Meyers of the Broomehill

West Brigade

May 21st

Jon Webster, Andrew Webster and Brian Conning went to a small fire

Which was caused by a lupin stubble that had been done 3 days prior

And the land owner thought that it was completely out

Wind on the Sunday caused ashed to flare up again and then the fire

trickled over the fire break and lit up a small tree on the road side

The town truck was taken down but not required as the farmer was there and with his fire unit put the tree out

He was going to make sure it was all safe



Tambellup VFES (Laurie Hull FCO)

- Quiet off season fire wise with no fires in town reported.
- The Unit assisted with fires around the Shire where possible, including one on Pootenup Rd yesterday.

Broomehill West (Ben Adam for Brant Dennis FCO)

- AGM held 21 March with appointments made (as per the Fire Break Order), and the fast fill trailer is with Brendon Boyle
- Two fires were well attended.
- A fire in a pine plantation requiring different considerations was a first for many.
- Funding has been secured for a new fast fill trailer, will be ready to pick up soon.
- Thanks to Kim and Cindy for their assistance over the past season.

Broomehill East (Nick Bowman for Josh Holmes FCO)

- AGM held and appointments made as per the Fire Break Order
- No fires since last meeting in March 2023.
- Permit conditions are considered too restrictive (to general business)
- Josh attended the FCO course in April 2023.

Tambellup West (Jedd Herbert FCO)

- AGM held and appointments made as per the Fire Break Order
- One fire since the last meeting in March 2023, in bush off Nymbup Rd. The incident was well attended by Tambellup West, Kojonup and Tunney brigades.

Tambellup East (Carl Letter for Chris Rumble FCO)

- One fire, on Pootenup Rd. No Tambellup East members able to attend.
- One radio is currently out of service, waiting for a new vehicle for fitting.

5.2 CHIEF BUSH FIRE CONTROL OFFICER REPORT

CBFCO Kim Oliver provided the following report:

- Welcome to new FCOs and brigade members
- Permits issued to 'repeat offenders' were carried out without incident.
- A number of 000 calls were received during the open burning period – most were false alarms from people not understanding that burns could be conducted. One call was for an escaped controlled burn.
- Attended the CBFCO forum at the DFES Bush Fire Centre of Excellence in July 2023. The forum was informative and provided an opportunity to meet with other CBFCOs. Highly recommend for upcoming CBFCOs to attend this forum.
- Thanks to everyone who has attended training, and to Cindy for organising.

5.3 COMMUNITY EMERGENCY SERVICES MANAGER REPORT***Training***

Another Rural Fire Awareness Course will be run on 3 November at the Tambellup CRC starting at 10am. Lunch provided.

A Ground Controller Course will be scheduled in November as well if there is enough interest. Note – A Ground Controller must be nominated when we request Water Bomber activation. Ideally a list of names will be put together that are qualified as GC to make it easier in the heat of the moment.

Is there other training you would like to see held?

Mitigation Works

Shire again will be conducting the mitigation works on the townsite UCL, including slashing and fire breaks.

The Bushfire Management Plan for the Shire will be completed in December and should be endorsed early next year so funding can be secured to complete high level works across both townsites. Community consultation will take place regarding the risks and the works to reduce the risk.

Membership List

Lists have been circulated tonight, get them back to me ASAP. This effects the insurance premium the Shire pays from the ESL so we need to keep the lists up to date as possible.

PPE

Circular went out a few weeks back, get those back ASAP. Due date 30 September.

Water Bomber Reload Training

Water Bomber reload training is being held at the Katanning airstrip on Saturday 4 November at 1pm. If interested let me know, the training takes approx 1 and a half hours depending on numbers attending.

Comments:

Discussion around Water Bomber training – if water bombers are called to an incident, consider having two ground controllers on site – one to scribe.

Ben Adam – Broomehill West has determined that the person in the BH West 5 position each year will complete Ground Controller training – this will ensure that over time there are plenty of people able to fill this role at a fire.

Laurie Hull – queried whether there would be training for people to assist manning the new fast fill trailers? For Brigades to consider.

5.4 DEPARTMENT OF FIRE AND EMERGENCY SERVICES REPORT

Nil.

5.5 CHIEF EXECUTIVE OFFICER REPORT

Nil.

5.6 RANGER REPORT

Nil.

6. MATTERS FOR DECISION

6.1 REVIEW OF BUSH FIRE BRIGADE STANDARD OPERATING PROCEDURES

The *Bush Fire Brigade Standard Operating Procedures 2023-2024* have been reviewed and the document is presented to the Bush Fire Advisory Committee for comment and recommendation for Council endorsement.

The Standard Operating Procedures (SOPs) provide information that will assist all volunteer Bush Fire Brigade members to conduct their activities safely and in accordance with legislation and established Shire and Department of Fire and Emergency Services (DFES) procedures.

The document is reviewed annually and circulated to Brigade members for their information and was last reviewed in March 2022.

The following new SOPs have been included:

- **SOP 1.09 Bush Fire Brigade Volunteers – Minimum Training Requirements** – In accordance with Work Health and Safety legislation, the Council has a duty of care to all its brigade volunteers to provide a safe working environment. This extends to ensuring the volunteers responding to a fire incident have received the appropriate training.
- **SOP 4.10 Aboriginal Cultural Heritage Act 1972 – Bushfire Incident** – To provide a standard process for brigade members to follow in support of the *Aboriginal Cultural Heritage Act 1972*.
- **SOP 4.11 Wind Farm Fire Fighting Procedures** – To provide a standard procedure for fighting fire in the Wind Farm area.
- **SOP 4.12 St John Ambulance Notification** – To ensure medical support is available to volunteer Bushfire Fighters in case of injury during a fire incident that is expected to be difficult to bring under control in a timely manner, and to ensure St John Ambulance have available volunteers to maintain an ambulance in case members are involved with the fire incident or roads are closed.

All existing SOPs have been reviewed, and minor amendments have been made including to the following SOPs:

- **SOP 1.03 Work Health & Safety – Incident/Injury/Hazard Reporting** – Appendix 1 – Shire of Broomehill-Tambellup Notification of Hazard/Injury/Incident Form updated.
- **SOP 1.05 Shire Owned Equipment at a Wildfire** – Appendix 2 – Inserted DFES Contract Machinery Log Sheet
- The term '*Occupational Safety & Health*' has been replaced throughout the document with '*Work Health & Safety*'

The draft has been provided to key brigade personnel for review prior to this meeting. Any amendments required can be noted and made to the final document.

For discussion and endorsement if appropriate.

Comments

SOP 4.11: Wind Farm Fire Fighting Procedures

- Map of water points at the Wind Farm to be circulated to CBFCO, DCBFCOs, FCOs Broomehill West and Tambellup West (Cindy)
- Clarify exclusion zone, currently 75m, taken from the Wind Farm Bush Fire Management Plan. Should this be greater? (Cindy has clarified – the stated exclusion zone of 75m is taken from the Flat Rocks Wind Farm Fire Management Plan as endorsed by the Council – August 2023).
- Fire break requirements (as per the approved Fire Management Plan) 20 metres diameter compacted gravel around the base of the turbine, in addition to 40 metres diameter with grass mowed to less than 100mm (total 60 metres). Once the site is operational this will be monitored by the Ranger as part of the annual inspection program.
- Confirm and circulate contact details for main contact at the Wind Farm in case of a fire (Cindy)
- Tanks at the Wind Farm are fitted with 75mm (3”) male camlocks. Can 3”to 2” adapters at each tank be requested? (Cindy)

Pam advised the Standard Operating Procedures are available on the Shire website and requested that the link to these be provided to all brigade members through Brigade WhatsApps. (Cindy to circulate link to FCOs)

Any further amendments should be advised to a Councillor or Cindy ASAP so they can be incorporated into the document that will be taken to the Council for endorsement.

OFFICER RECOMMENDATION/COMMITTEE DECISION

That it be recommended to the Council that the Bush Fire Brigade Standard Operating Procedures 2023-2024, subject to amendments noted, be endorsed.

Attachment 5.1.1 Standard Operating Procedures 2023-2024



BUSH FIRE BRIGADE STANDARD OPERATING PROCEDURES

2023-2024



This page left blank deliberately

DRAFT

Contents

Glossary of terms used in this document	5
Section 1: Administration.....	6
SOP 1.01 Communication Systems	7
SOP 1.02 Permits to set Fire to the Bush	10
SOP 1.03: Work Health & Safety – Incident/Injury/Hazard Reporting	12
Appendix 1 – Shire of Broomehill-Tambellup Notification of Hazard/Injury/Incident Form	13
SOP 1.04: Media and Police Statements.....	17
SOP 1.05: Shire Owned Equipment at a Wildfire.....	18
Appendix 2 – DFES Contract Machinery Log Sheet.....	19
SOP 1.06: Brigade Incident Reporting.....	20
Appendix 3: Incident Report forms	22
SOP 1.07: Appointment of Bush Fire Control Officers.....	24
SOP 1.08: Appointment of Fire Weather Officers.....	26
SOP 1.09 Bush Fire Brigade Volunteers – Minimum Training Requirements.....	28
Section 2: Fire Prevention & Mitigation.....	30
SOP 2.01: Fuel Reduction Burns.....	31
SOP 2.02: Firebreak Inspections	34
SOP 2.03: Harvest and Vehicle Movement Bans	36
Appendix 4: Harvest Ban Notification Form.....	38
Section 3: Call Out and Mobilisation.....	39
SOP 3.01: Incident Announcement	40
SOP 3.02: Bushfire Warning System	42
SOP 3.03: Fire Appliances Outside Municipality Boundaries.....	44
Section 4: Incident Control and Response	45
SOP 4.01: Wildfire Operational Management	46
SOP 4.02: Incident Control System - AIIIMS.....	48
SOP 4.03: Traffic Management at Bushfires	50
SOP 4.04: Entrapment at a Bushfire – Burnover Procedure.....	54
SOP 4.05: Red Flag Warning.....	56
SOP 4.06: Brigades Responding to Fires that may be Suspicious	58
SOP 4.07: Use of ‘Class A’ Foam.....	59
SOP 4.08: Incident Escalation.....	61
SOP 4.09: Transfer of Incident Control – Interagency	63
Appendix 5: SMEACS Checklist.....	65

SOP 4.10:	<i>Aboriginal Cultural Heritage Act 1972 – Bushfire Incident</i>	66
SOP 4.11:	Wind Farm Fire Fighting Procedures	67
SOP 4.12:	St John Ambulance Notification	69
Section 5:	Safety.....	70
SOP 5.01:	Personal Protective Equipment.....	71
SOP 5.02:	LACES	72
	Appendix 6 – LACES.....	73
SOP 5.03:	Drugs and Alcohol.....	74
SOP 5.04:	Drip Torches.....	76
SOP 5.05:	Driving Guidelines.....	78
SOP 5.06:	Electrical Hazards.....	80
SOP 5.07:	Burnover Blankets	82
SOP 5.08:	Chainsaws	83
SOP 5.09:	Refilling Motors at Fire Incidents	85
Section 6:	Equipment Management	87
SOP 6.01:	Fire Appliances – Maintenance and Modification.....	88
SOP 6.02:	Automatic Vehicle Locator - AVL.....	90

Glossary of terms used in this document

<i>CBFCO</i>	<i>Chief Bush Fire Control Officer</i>
<i>CEO</i>	<i>Chief Executive Officer</i>
<i>CESM</i>	<i>Community Emergency Services Manager</i>
<i>COMCEN</i>	<i>Communication Centre (DFES)</i>
<i>DBCA</i>	<i>Department of Biodiversity, Conservation & Attractions</i>
<i>DCBFCO</i>	<i>Deputy Chief Bush Fire Control Officer</i>
<i>DFES</i>	<i>Department of Fire & Emergency Services</i>
<i>FCO</i>	<i>Fire Control Officer</i>
<i>IC</i>	<i>Incident Controller</i>
<i>IMT</i>	<i>Incident Management Team</i>
<i>RDC</i>	<i>Regional Duty Coordinator</i>
<i>SOP</i>	<i>Standard Operating Procedure</i>

DRAFT

Section 1: Administration

DRAFT

SOP 1.01 Communication Systems

PURPOSE

To set out the various methods of communication employed by the Shire and bush fire brigades in incident notification, brigade mobilisation and public announcements.

INTRODUCTION

Various methods of communication have been engaged by the Shire and Brigades to ensure messages are delivered efficiently and effectively to the respective audience.

1. BUSH FIRE RADIO NETWORK

The Shire of Broomehill-Tambellup presently uses VHF radio communications through the WA Emergency Radio Network to provide communications for its Bushfire Brigades.

The radio network is supported by two repeater sites at Fairfield Road and Jam Creek Road. The Shire of Broomehill-Tambellup Bushfire Brigades and the Tambellup VFES utilise VHF Channel 322 (Tambellup) and 231 (Broomehill) for its strategic operational communications and UHF Channel 5 for its fire site operational communications.

In the event that the Shire of Broomehill-Tambellup Bush Fire Radio Network repeaters fail, permission can be requested from neighbouring shires through the CBFCO to use the following VHF Channels:

Cranbrook East	WAERN Channel 163
Cranbrook West	WAERN Channel 162
Gnowangerup	WAERN Channel 200
Katanning	WAERN Channel 230
Kojonup	WAERN Channel 234

The Regional Duty Coordinator (phone 1800 314 644) must be notified immediately of any instances where radio communications are down to enable timely repairs.

Restrictions on use of the Bushfire Radio Network

Because the Shire's radio network is an emergency facility, Bush Fire Brigades should only use it for:

- Official Bushfire Brigade operations, training & administration purposes, OR
- Any other genuine emergency purposes.

The Shire of Broomehill-Tambellup Bush Fire Radio Network is not to be used for private purposes other than genuine emergencies.

Users should be aware the radio network is an open network and as such, sensitive information should be conveyed in person, by phone or other method.

2. SMS

The Shire of Broomehill-Tambellup maintains SMS listings of Shire residents, brigade members, residents and brigade members of neighbouring local governments, contractors and others.

The SMS system is used by the Shire for a variety of purposes, including notification and updates of harvest bans, Total Fire Bans, road closures, and other emergency matters where information is required to be delivered to a broad audience quickly.

SMS messages can be sent to specific brigades, or to a general audience.

The CBFCO, Deputy CBFCOs, CESM and Shire administration staff have access to the SMS system for broadcast and management purposes.

DFES also maintains brigade SMS lists, primarily used to mobilise brigades to incidents reported through the 000 system. Requests for brigade mobilisation through this avenue should be made by contacting DFES Communications (Comcen) on 1800 198 140.

3. WHATSAPP

WhatsApp is used by the brigades as an informal communication method for the Brigade Leadership Group (CBFCO, Deputy CBFCOs and brigade FCOs, CESM, Shire administration staff) to monitor weather conditions, and to circulate Permits to Burn and other information that needs to be circulated to the brigades. This group is managed by the CBFCO.

WhatsApp groups have been established by individual brigades for their own use in response and provision of information. These groups are managed by the individual brigades.

4. RADIO BROADCAST

The Shire utilises radio broadcast (through ABC and Triple M) to advise the broader community when harvest bans and/or road closures have been imposed or lifted.

5. HARVEST BAN HOTLINE

The Harvest Ban Hotline is a 24/7 recorded message service, phone number is 9825 1042. This service is held by the Shire, and is maintained by the CBFCO, Deputy CBFCO, CESM and Shire administration staff when messages are required to be updated.

6. EMAIL

Email is utilised to advise specific contacts of harvest ban and road closure information. The contact list is maintained by the Shire and circulated to the CBFCO, Deputy CBFCOs and CESM as required.

7. SOCIAL MEDIA

The Shire utilises its Facebook page to broadcast information to residents, including information relating to emergencies such as notification of harvest bans, road closures, and incident updates when required. Access to the Facebook page is restricted to Shire administration staff, and requests for publication of information via this media should be submitted to the CEO.

RELEVANT INFORMATION	
ADOPTED	December 2020
REVIEWED	September 2023
SOP	Nil
COUNCIL POLICY	1.23 Public Relations - Press Releases
LEGISLATION	<i>Bush Fires Act 1954 State Emergency Management Policy s.5.6 Emergency Public Information</i>

DRAFT

SOP 1.02 Permits to set Fire to the Bush

PURPOSE

To ensure that officers issuing permits abide by best practice procedures.

To maintain record keeping requirements for all Permits to Set Fire to the Bush (Form 3, *Bush Fires Act 1954*) issued by the Shire.

INTRODUCTION

The *Bush Fires Act 1954* makes provision for Fire Control Officers and duly authorized officers to issue Permits to Set Fire to the Bush.

It is a statutory requirement to keep records of permits issued or a period of one year in case of an insurance claim.

GUIDELINES

Permits may be issued by the Chief Bush Fire Control Officer and Deputy Bush Fire Control Officers, or Brigade Fire Control Officers in their approved area only.

Approved permits are to be circulated via the Brigade Leaders internal communications network (WhatsApp), and a copy is also to be forwarded to the Community Emergency Services Manager for recording into the Shire's records system.

PERMIT CONDITIONS

Permits should not be issued if the permit holder cannot be in attendance on the day after the burn.

The issuing Fire Control Officer must stress to the person to:

- NOTIFY all neighbours;
- PICK UP permit and READ conditions; and
- INSPECT the fireground the next day and when the next strong winds occur.

Two or more firefighting units are to be in attendance at all fires lit under permit. Alternative arrangements may be made for small burns within the gazetted town sites.

The issuing Fire Control Officer should write down any other conditions they believe are necessary. Permit holders must comply with these additional conditions.

Copies of all Permits to Set Fire to the Bush are to be kept for a period of one year after the fire season they pertain to, and then discarded.

Permits to do Protective Burning

To ensure an appropriate level of protective burning can be carried out throughout the Shire when conditions are suitable, the following arrangements have been set in place:

During the period 1 October to 30 November, permits to burn may be issued for protective burning to be completed in accordance with the Fire Break Order. Additionally, burns may be conducted on days with a HIGH Fire Danger Rating and Fire Behaviour Index not exceeding 35, between the hours of 6pm -12 midnight of the same day, at the discretion of the Gazetted Fire Weather Officer.

During the Restricted Burning period 14 March to 15 April:

- a. Permits to burn (not including timber or chaff piles) may be issued, with burns to be completed up to midnight on the day before the day of a HIGH Fire Danger Rating with a Fire Behaviour Index not exceeding 35;
- b. Permits issued for days with HIGH Fire Danger Rating and a Fire Behaviour Index exceeding 35 will not be valid in accordance with existing procedures;
- c. All permits are suspended for the two days prior to a forecast EXTREME or CATASTROPHIC day.

These arrangements will be reviewed annually.

RELEVANT INFORMATION	
ADOPTED	December 2008
REVIEWED	September 2023
SOP	SOP 1.01 Communications Systems
COUNCIL POLICY	Nil
LEGISLATION	<i>Bush Fires Act 1954 s.18</i> <i>Bush Fires Regulations 1954 Part IV</i>

SOP 1.03: Work Health & Safety – Incident/Injury/Hazard Reporting

PURPOSE

To provide a procedure for the reporting, recording and investigation of incident, injuries and hazards in accordance with the *Work Health & Safety Act 2020* and Regulations.

INTRODUCTION

The Shire is committed to minimising the risk of injury, harm or damage to its emergency services personnel and to Brigade and Council owned property.

REPORTING

In accordance with the above, any member who has an injury, accident or notes a hazard shall be required by the Shire of Broomehill-Tambellup to complete a 'Notification of Hazard/Injury/Incident' form (Appendix 1).

ALL REPORTS SHALL BE TREATED AS CONFIDENTIAL AND INTERNAL TO THE SHIRE OF BROOMEHILL-TAMBELLUP.

INVESTIGATION

All reported incidents/hazards/injuries shall be investigated by the CBFCO/CESM to identify any gaps in procedure that may have allowed the incident to occur.

As a matter of courtesy, the CESM will notify the Shire's Work Health & Safety Committee when a report is received.

The objective of the reporting process is not to attribute blame, but rather to minimise the likelihood of a repeat occurrence.

Any member needing to make a report should contact the CBFCO. Copies of the incident notification form can be obtained on request from the CESM.

RELEVANT INFORMATION	
ADOPTED	December 2008
REVIEWED	September 2023
SOP	Nil
COUNCIL POLICY	2.2 Safety and Health in the Workplace
LEGISLATION	<i>Work Health & Safety Act 2020 Part 3</i>

Appendix 1 – Shire of Broomehill-Tambellup Notification of Hazard/Injury/Incident Form



BT GRIP No:	SYNERGY REF:
--------------------	---------------------

ABOVE FOR OFFICE USE ONLY – WORKS ADMIN OFFICER TO COMPLETE

Notification of HAZARD / INJURY / INCIDENT

Part A: Occurrence:			
Hazard <input type="checkbox"/>	Near Miss <input type="checkbox"/>	Property Loss/Damage <input type="checkbox"/>	Injury/disease <input type="checkbox"/>
Fire <input type="checkbox"/>	Environment <input type="checkbox"/>	Security Breach <input type="checkbox"/>	Improvement Suggestion <input type="checkbox"/>
Type of Hazard – please select one			
Biological <input type="checkbox"/>	Handling of Chemical <input type="checkbox"/>	Electrical <input type="checkbox"/>	Ergonomic <input type="checkbox"/>
Plant/Vehicle <input type="checkbox"/>	Machine <input type="checkbox"/>	Equipment Defect <input type="checkbox"/>	Equipment Malfunction <input type="checkbox"/>
Fire/Emergency <input type="checkbox"/>	Manual Handling <input type="checkbox"/>	Material (eg Asbestos) <input type="checkbox"/>	Person <input type="checkbox"/>
Pressure <input type="checkbox"/>	Procedural Breach <input type="checkbox"/>	Road Conditions <input type="checkbox"/>	Temperature <input type="checkbox"/>
Slip/Trip/Fall (same level) <input type="checkbox"/>	Vibration <input type="checkbox"/>	Fauna <input type="checkbox"/>	Fall from Height <input type="checkbox"/>
Name of Person reporting Occurrence:		Department/Area:	
Date (DD/MM/YYYY) and time (00:00) of Occurrence:		Date (DD/MM/YYYY) and time (00:00) reported:	
Name of Injured/involved Person:		Department/Area:	
Vehicle/Workplace/Project/Site Location (please be specific where incident occurred):			
Details: (Describe/outline the tasks being performed and the sequence of events, use a Witness Statement Form and attach if appropriate)			
Immediate Actions/Remedial Actions taken (What actions were taken to immediately control the hazard and prevent recurrence?):			

Any other suggestions/comments:	
Person completing report (signature):	Injured/Involved person (signature):

Part B: First Aid Treatment:

FIRST AIDER TO COMPLETE

Hazard/Injury Incident Code – see table below	
Nature (Characteristic of injury)	
Mechanism (Action, Exposure or event of injury)	
Agency (Object, substance, or direct cause of injury)	
Medical Treatment received (Hospital/Doctor)*	Yes* / No

*If yes, please provide First Certificate of Capacity and Form 2b within 3 days to the Strategic Support & Projects Officer who will ensure LGIS Workcare are notified

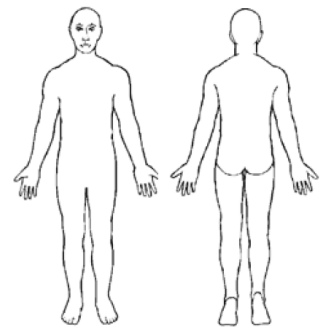

Circle Injured Area

First Aid Treatment Provided (Record any observation/treatment provided, as well as advice given to injured person):

First Aider Name:	Signature:
-------------------	------------

*Ensure used first aid provisions are documented for timely replacement**

Part B Reckoner		
NATURE	MECHANISM	AGENCY
1. Amputation	1. Collided With	1. Biological
2. Burn	2. Contact/Exposure to Biological Factors	2. Chemical
3. Concussion	3. Contact/Exposure to Heat or Cold	3. Electrical
4. Contusion/Bruising	4. Contact with Chemical	4. Human
5. Crush Injury	5. Contact with Electricity	5. Indoor
6. Exposure (eg. Heat/Noise)	6. Exposure to Dust	6. Insect/Animal
7. Fracture/Dislocation	7. Exposure to Gas/Fumes	7. Light Vehicle
8. Foreign Body	8. Exposure to Mechanical Vibration	8. Machinery/Fixed Plant
9. Irritation/Allergy	9. Exposure to Noise	9. Mobile Plant/Equipment
10. Open Wound/Cut/Graze	10. Exposure to Radiation (Welding)	10. Non-Powered Tool/Equipment/Appliance
11. Poisoning/Bite/Chemical	11. Falls from Height	11. Powered Tool/Equipment/Appliance
12. Shock	12. Hit by Moving Object	12. Radiation (Welding)
13. Sprain/Strain	13. Low-muscle loading	13. Outdoor Environment
	14. Sprain/Strain	
	15. Slip/Trip/Fall	

Part C: Potential Risk Rating - please refer to the Risk Table that follows**SAFETY REP & SUPERVISOR/MANAGER TO COMPLETE**

Part C Likelihood Matrix; please choose the most appropriate

LEVEL	DESCRIPTOR	DETAILED DESCRIPTION	OPERATIONAL FREQUENCY	PROJECT FREQUENCY
1	Rare	The event may only occur in exceptional circumstances	Less than once in 15 years	Less than 10 % chance of occurrence
2	Unlikely	The event could occur at some time	At least once in 10 years	10%- 40% chance of occurrence
3	Possible	The event should occur at some time	At least once in 3 years	40%-60% chance of occurrence
4	Likely	The event will probably occur in most circumstances	At least once per year	60%-90% chance of occurrence
5	Almost Certain	The event is expected to occur in most circumstances	More than once per year	Greater than 90% chance of occurrence

Part C Consequence Matrix; please choose the most appropriate

LEVEL	DESCRIPTOR	SAFETY/HEALTH (Physical)	SAFETY/HEALTH (Psych)
1	Insignificant	Negligible injuries	Temporary - no leave taken, short term impact
2	Minor	First aid injuries	Sick leave - short term impact Recovery 1-3 weeks
3	Moderate	Medical type injuries	Significant – Non-permanent, Longer term illness Recovery 1-6 months
4	Major	Lost time injury	Longer term illness Severe trauma, Extended incapacity
5	Catastrophic	Fatality, Permanent Disability	Death, Permanent severely disabling illness e.g. Post-Traumatic Stress Disorder

Shire of Broomehill-Tambellup Risk Rating

Consequence		Insignificant	Minor	Moderate	Major	Catastrophic
Likelihood		1	2	3	4	5
Rare	1	Low (1)	Low (2)	Low (3)	Low (4)	Moderate (5)
Unlikely	2	Low (2)	Low (4)	Moderate (6)	Moderate (8)	High (10)
Possible	3	Low (3)	Moderate (6)	Moderate (9)	High (12)	High (15)
Likely	4	Low (4)	Moderate (8)	High (12)	High (16)	Extreme (20)
Almost Certain	5	Moderate (5)	High (10)	High (15)	Extreme (20)	Extreme (25)

ENTER SELECTIONS INTO TABLE

Consequence:		Ranking:
Likelihood:		

Part D: Forward Action:**MANAGER TO COMPLETE**

The table below identifies further actions required after scoring from Part C: Potential Risk Rating (ie: undertake the minimum actions outlined below by the relevant risk rating and initial when actions are complete)

Potential Risk Rating	Action Required	Complete
Low	<ul style="list-style-type: none"> Immediate actions taken entered into GRIP Tracker 	
	<ul style="list-style-type: none"> Include in the Agenda of the next scheduled Safety & Health Committee Meeting for further action (if necessary) and review the Risk Assessment 	
	<ul style="list-style-type: none"> Incident brought up and remedial action discussed at the next day's pre-start 	
	<ul style="list-style-type: none"> CEO or most Senior Manager notified (within 48 hours) 	
Potential Risk Rating	Action Required	Complete
Medium	<ul style="list-style-type: none"> Immediate actions taken & entered into GRIP Tracker 	
	<ul style="list-style-type: none"> Internal Safety Alert with immediate action placed on Safety Information Board (within 24 hours) 	
	<ul style="list-style-type: none"> Include in the Agenda of the next scheduled Safety & Health Committee Meeting for further action (if necessary) and review the Risk Assessment 	
	<ul style="list-style-type: none"> Incident brought up and remedial action discussed at the next Toolbox Meeting for Long term action 	
	<ul style="list-style-type: none"> CEO or most Senior Manager notified by end of shift 	
Potential Risk Rating	Action Required	Complete
High	<ul style="list-style-type: none"> Immediate actions taken entered into GRIP Tracker 	
	<ul style="list-style-type: none"> Internal Safety Alert with immediate action placed on Safety Information Board (24 hours) 	
	<ul style="list-style-type: none"> Incident brought up and remedial action discussed at next morning's Toolbox Meeting for Long term action 	
	<ul style="list-style-type: none"> Incident Investigation Procedure initiated 	
	<ul style="list-style-type: none"> Include in the Agenda of the next scheduled Safety & Health Committee Meeting for further action (if necessary) and review the Risk Assessment 	
	<ul style="list-style-type: none"> CEO or most Senior Manager notified by quickest possible means 	
	<ul style="list-style-type: none"> LGIS Regional Risk Coordinator contacted same day 	
Potential Risk Rating	Action Required	Complete
Extreme	<ul style="list-style-type: none"> Immediate actions taken entered into GRIP Tracker 	
	<ul style="list-style-type: none"> Internal Safety Alert with immediate action placed on Safety Information Board (within 24 hours) 	
	<ul style="list-style-type: none"> Incident brought up and remedial action discussed at end of shift Toolbox Meeting 	
	<ul style="list-style-type: none"> Incident Investigation Procedure initiated; facilitated by LGIS Regional Risk Coordinator 	
	<ul style="list-style-type: none"> Include in the Agenda of the next scheduled Safety & Health Committee Meeting for further action (if necessary) and review the Risk Assessment 	
	<ul style="list-style-type: none"> CEO or most Senior Manager and LGIS Regional Risk Coordinator notified by quickest possible means 	

Supervisor/Manager Signature:	Safety Rep Signature:
CEO Signature:	Date:

It is the Managers responsibility to fulfil the actions required to prevent recurrence.

SOP 1.04: Media and Police Statements

PURPOSE

To provide standard arrangements for the provision of statements to the media and police regarding incidents.

INTRODUCTION

Personnel attending incidents may occasionally be required to submit a statement to Police for internal police inquiries and/or presentation to a Coroner's inquest.

During large-scale incidents media also seek personnel to make statements.

POLICE STATEMENTS

Statements are not to be submitted, presented or made either verbally or in writing directly to any police officer in regard to any incident attended.

Upon receiving a request for a witness statement, the witness (Shire employee or volunteer) is to contact the Chief Executive Officer.

The Chief Executive Officer will provide the witness with internal advice and support and will solicit external legal advice if considered necessary.

The Chief Executive Officer will assist the witness through the statement development and delivery process.

MEDIA STATEMENTS

No Shire employees or volunteers are authorised to speak on behalf of the Shire to the media.

All media statement requests should be referred to the Chief Executive Officer or Shire President.

RELEVANT INFORMATION	
ADOPTED	December 2008
REVIEWED	September 2023
SOP	SOP 1.01 – Communications Systems
COUNCIL POLICY	1.23 Public Relations – Press Releases
LEGISLATION	<i>Local Government Act 1995 s.2.8</i>

SOP 1.05: Shire Owned Equipment at a Wildfire

PURPOSE

To establish a procedure for the call out of Shire equipment to a fire.

INTRODUCTION

Council is fully supportive of our volunteer brigades' efforts to protect the Shire from a dangerous fire situation. To that end, Shire owned plant and equipment is available to assist in the containment of a fire.

PROCEDURE

- The Fire Control Officer (FCO) or person in control of the fire, is to determine if the equipment is required.
- The FCO or person in control of the fire is to contact the Chief Executive Officer to request the Shire equipment to attend the fire.
- If the Chief Executive Officer is unavailable, authority to approve the use of plant and equipment will be delegated to the Manager of Works, or Manager Finance and Administration.
- Requests for Shire equipment are to be for assistance in the containment and control of wildfires only.
- Requests from landowners for use of machinery/staff to assist in "mopping up" procedures will be charged at private works rates.
- If land tenure is DBCA/Unallocated Crown Land/Unmanaged Reserves the land manager/agency must be contacted for approval at the time the machinery is required to enable the Shire to claim payment for equipment use.
- If equipment is required that the Shire cannot supply, eg bulldozer, contact should be made with the CESM, or Regional Duty Coordinator on 1800 314 644 for approval to hire this equipment. NOTE – Authorisation must be provided prior to hiring equipment so the cost can be covered by DFES. A 'Contract Machinery Log Sheet' must be completed by the IC/CESM before engaging equipment if DFES are covering the cost.

RELEVANT INFORMATION	
ADOPTED	March 2009
REVIEWED	September 2023
SOP	SOP 4.01 Wildfire Operational Management
COUNCIL POLICY	4.9 Shire Owned Equipment at a Wildfire
LEGISLATION	<i>Bush Fires Act 1954 s.36</i>

Appendix 2 – DFES Contract Machinery Log Sheet



DBCA FIRE238 / DFES Contract Machinery Log - Must be signed off at the end of each shift

CONTRACT MACHINERY LOG SHEET

(Each Log sheet covers the time worked and / or on standby during a single shift period only)

115661

Date: Contractor's Name:

Shift Number: Operator's Name:

Region / District: Machine Make:

Fire/Burn/Incident Name: Machine Type:

Fire/Burn/Incident Number: Registration Number:

AVL ID Number (if required) Controlling Agency: DBCA DFES LG (Please Tick)

CONTRACT MACHINE HIRE CLASSIFICATION

Machine and Operator OR Operator Only

SHIFT TIMES

Please tick	Start Time	Finish Time	Total Hours
Working <input type="checkbox"/> Standby <input type="checkbox"/>			
Working <input type="checkbox"/> Standby <input type="checkbox"/>			
Working <input type="checkbox"/> Standby <input type="checkbox"/>			
Working <input type="checkbox"/> Standby <input type="checkbox"/>			

Has DBCA/DFES provided fuel to this machine during this shift? Yes / No

If Yes, how many litres have been supplied during this shift, litres

Operator's Name: Signature: Date: / /

Approving Dept Officer Name: Signature: Date: / /

COMMENTS:

.....

.....

.....

White Copy: Contractor's copy, attach to invoice when submitting to Department / Agency for payment.

Green Copy: Department copy, return to District / Region Finance & Administration Officer or IMT Finance Officer.

Yellow Copy: Remains in book.

SOP 1.06: Brigade Incident Reporting

PURPOSE

To ensure that accurate records of all fire incidents within the Shire are reported and that reports are submitted to the appropriate agencies and officers.

INTRODUCTION

It is a requirement of the *Bush Fires Act 1954* and *Bush Fires Regulations 1954* that all fire incidents within a local government are reported and that such reports are provided to the Department of Fire and Emergency Services no less than once per financial year.

INCIDENT REPORTS

Fire Control Officers are to complete an Incident Report Bushfire Form and/or an Incident Attendance Form (Appendix 1) every time their Brigade is mobilised in response to any fire incident or false alarm.

The Incident Report should include the Incident Number generated by DFES Communication Centre (Comcen) – phone 1800 198 140. This is obtained by the CBFCO or Incident Controller at the conclusion of the incident.

The Controlling (primary) brigade is required to complete and submit both the 'Bushfire' and 'Attendance' reports. Assisting brigades are required to complete and submit the 'Attendance' report.

Once completed, reports are to be submitted to the CESM, for entry into the DFES Reporting system, and for the Shire's records. A copy should be submitted to the CBFCO for information.

The report should be completed as soon as possible after a fire (preferably within 24hrs) and submitted within seven days of the fire/incident.

SUSPICIOUS FIRES

The CBFCO or CESM should be notified immediately if any fire attended by brigades is deemed suspicious and the area should be secured. In addition to the Incident Report Bushfire and Attendance forms, the Incident Controller should complete a Wildfire Attendance & Information Report. The report should be forwarded to the CESM within 24 hours of the fire.

The purpose of this latter report is to assist the Arson Squad with its investigations. Wildfire Attendance & Information Reports are available online at the Volunteer Hub or from the CESM.

RELEVANT INFORMATION	
ADOPTED	December 2008
REVIEWED	September 2023
SOP	SOP 4.01 Wildfire Operational Management SOP 4.02 Incident Control Systems – AIIMS SOP 4.06 Brigades Responding to Fires that may be Suspicious
COUNCIL POLICY	Nil
LEGISLATION	<i>Bush Fires Act 1954 s.50</i> <i>Bush Fires Regulations 1954 s.43</i>

Appendix 3: Incident Report forms



IRS Report Form

Bushfire

ONLY fill in this form if Primary Responder / Brigade / Unit

Block A – Primary Report Header	DFES Incident # <input style="width: 20px; height: 20px;" type="text"/> <input style="width: 20px; height: 20px;" type="text"/> <input style="width: 20px; height: 20px;" type="text"/> <input style="width: 20px; height: 20px;" type="text"/> <input style="width: 20px; height: 20px;" type="text"/>
Unit/Brigade Name: _____	
Date/s: _____ to _____	
Start Time: _____ : _____ hrs Finish Time _____ : _____ hrs	
Type of Fire: Grass <input type="checkbox"/> Crop <input type="checkbox"/> Scrub <input type="checkbox"/> Forest <input type="checkbox"/> Pole <input type="checkbox"/> Rubbish <input type="checkbox"/>	
Report of smoke – no fire <input type="checkbox"/> Unauthorised Burn <input type="checkbox"/> Control Burn <input type="checkbox"/>	
Loc / St No.: _____ Rd / St Name: _____	
Town / Suburb: _____ Map Ref / GPS Co-ordinates: _____	
What is the Property used for? _____	
Action Taken: Fire Extinguished <input type="checkbox"/> Investigation Only <input type="checkbox"/> Called Off <input type="checkbox"/> Other <input type="checkbox"/> _____	
Block E - Ignition	
Who was in the area at the time of fire? _____	
Where did the fire start? _____	
How did the fire start? _____	
Was any equipment involved in ignition? _____	
Do you think the fire was: Deliberate (have evidence) <input type="checkbox"/> Suspicious <input type="checkbox"/> Accidental <input type="checkbox"/> Natural <input type="checkbox"/>	
Result of a Planned Burn <input type="checkbox"/>	
Block F- Fire Fighting	
How was the fire fought? Appliance Hose Reel <input type="checkbox"/> Constructed fire break <input type="checkbox"/> Portable Extinguisher <input type="checkbox"/>	
Hand Tools (e.g. garden hose, bucket, shovel) <input type="checkbox"/> Self-Extinguished <input type="checkbox"/> Back Burn <input type="checkbox"/>	
Other _____	
Block G + H – Bush Forest Grass + Block Exposures - Structures	
Area Burnt: Private (ha) _____ Public (ha) _____ Estimated total \$ value: _____	
Description and amounts of Losses: (e.g. fencing, sheds, livestock, machinery) _____	
Other Addresses affected by the fire? _____ % Damaged: _____	
Permit: Required? Yes <input type="checkbox"/> No <input type="checkbox"/> Issued? Yes <input type="checkbox"/> No <input type="checkbox"/> Complied With? Yes <input type="checkbox"/> No <input type="checkbox"/>	
Block Sign Off	
Were any Agencies notified / attended? (e.g. Western Power, DEC) _____	
Comments: _____	
Incident Control Officer: _____ Signature: _____ Phone No.: _____	
Officer completing this Form: _____ *This form MUST be accompanied with an Attendance Form	

*Only BFS: If form not entered in IRS then please FAX to 1800 309 999 or EMAIL to reports@dfes.wa.gov.au



IRS Report Form

Attendance

Fill in Block A if Supporting Responder / Brigade / Unit

DFES Incident #

Block A – Incident Header

Unit/Brigade Name: _____ Primary Brigade Name: _____

Date/s: _____ to _____ Start Time: _____ : _____ hrs Finish Time _____ : _____ hrs

Loc / St No: _____ Rd / St Name: _____

Town / Suburb: _____

Action Taken: Fire Extinguished Investigation Only Called Off Other _____

Comments: _____

ALL Responders MUST fill in Resources and Personnel

Resources Travel Code: 1 = Lights & Sirens 3 = Normal Road 5 = Upgraded 7 = Downgraded

1.	Resource (Res.) Name (include Brigade Name)	Depart Station	On Scene	Depart Scene	On Station	Travel Code	Km's to Incident
2.							
3.							
4.							
5.							
6.							
7.							
8.							
9.							
10.							

Personnel

* Circle number of who was driver

1.	2.	3.	4.	5.	6.	7.	8.	9.	10.

Other Attendees Appropriate response

1.	2.	Private Vehicle	Farmer Response Vehicle	Support at Station Only
2.				
3.				
4.				
5.				
6.				
7.				
8.				
9.				
10.				

Officer completing this form: _____ Signature: _____ Vol. No. _____

*Only BFS: If form not entered in IRS then please FAX to 1800 309 999 or EMAIL to reports@dfes.wa.gov.au

SOP 1.07: Appointment of Bush Fire Control Officers

PURPOSE

To outline the requirements for the appointment of Bush Fire Control Officers.

INTRODUCTION

Within the Bushfire Brigades, officers are appointed by the Council to undertake various roles and responsibilities. The persons occupying these positions, although volunteers, are nonetheless officers of the Council and are appointed by the Council (under section 38 of the *Bush Fires Act 1954*) upon their nomination by the Brigade and endorsement by the Bush Fire Advisory Committee and the Council.

In accordance with Work Health and Safety legislation, the Council has a duty of care to all its brigade volunteers to provide a safe working environment. This extends to ensuring Fire Control Officers are appropriately skilled to manage a fire incident, and the volunteers assisting have received the appropriate training.

Establishing the rules for the appointment of Bush Fire Control Officers and setting minimum requirements for training of volunteers will assist in meeting the Council's obligations for duty of care.

This policy provides the eligibility criteria for a person to be appointed as a Bush Fire Control Officer:

1. To be eligible for appointment as a Bush Fire Control Officer a person must have completed the Bush Fire Control Officer Training Program not more than five years prior to appointment.
2. Notwithstanding Item 1 above, a person will be eligible for appointment as a Bush Fire Control Officer if they complete the Bush Fire Control Officer Training Program within six months of appointment.
3. For a person to continue as a Bush Fire Control Officer they must complete the Bush Fire Control Officers Course or a Refresher Course at intervals of no more than every ten years.
4. Nominations of Bush Fire Control Officers from Brigades should be endorsed by the Bush Fire Advisory Committee for recommendation to Council by 1 May each year.
5. A Bush Fire Control Officer, other than the Chief or Deputy Chief Bush Fire Control Officer shall not issue a Permit to Burn for land within another Shire of Broomehill-Tambellup Bush Fire Brigade district unless mutual agreement exists between the Bush Fire Control Officers concerned.

PROCEDURE

- Brigades are to hold their Annual General Meetings during March each year. At that meeting, nominations for the positions of Captain/Fire Control Officer, lieutenants, radio operators, secretary and any other position as identified by the brigade are determined.
- Fire Control Officer nominations are to be presented to the Bush Fire Advisory Committee meeting held in March/April each year for endorsement.

- The Bush Fire Advisory Committee will make a recommendation to the Council by 1 May each year, that the Fire Control Officers be appointed as endorsed.

RELEVANT INFORMATION	
ADOPTED	December 2020
REVIEWED	September 2023
SOP	Nil
COUNCIL POLICY	2.2 Safety & Health in the Workplace 6.2 Bush Fire Control Officers and Volunteers
LEGISLATION	<i>Bush Fires Act 1954 s.38</i> <i>Work Health & Safety Act 2020, Part 2, Division 3, s.22</i>

SOP 1.08: Appointment of Fire Weather Officers

PURPOSE

To outline the requirements for the appointment of Fire Weather Officers and their role in endorsing Permits to Burn on days of High, Extreme and Catastrophic Fire Danger Ratings.

INTRODUCTION

Fire Weather Officers are nominated annually by Bush Fire Advisory Committee and approved by Council prior to appointment and Gazetted by DFES.

The authority of a Fire Weather Officers is restricted to a specific area within the Local Government area. An authorised Fire Weather Officer is permitted to override Permits to Burn when the Fire Danger Rating is High, Extreme or Catastrophic by the Bureau of Meteorology under *s38 Bush Fires Act 1954*.

To override a permit Fire Weather Officers must consult with the Chief Bush Fire Control Officer and the Deputy Chief Bush Fire Control Officers.

Fire Danger Rating	Fire Behaviour Index (FBI)
No Rating	0 - 11
Moderate	12 - 23
High	24 - 49
Extreme	50 - 99
Catastrophic	100

Using the Aurora Fire Behaviour Calculator App (available to Fire Weather Officers) an assessment can be made to determine whether the permit should be authorised. Details of the App can be obtained from the CBFCO or CESM.

If the permit is to be authorised the permit holder will be required to log their burn via DFES Communications (if not already a condition of the permit). The Fire Weather Officer reserves the right to add other conditions to the 'Permit to Burn' to allow the permit activities to be conducted in a safe manner.

The authorising Fire Weather Officer must communicate details of the permitted burn to brigades via the WhatsApp groups before the permit holder can commence their hazard reduction activity.

PROCEDURE

Once a request has been received by a Fire Weather Officer to endorse a Permit to Burn on a Fire Danger Rating of HIGH or above, the Fire Weather Officer must contact the CBFCO who will discuss the request with the DCBFCOs and FCOs.

If the request is approved, the conditions under which the burn can take place must be included on the 'Permit to Burn' and a copy forwarded to the CBFCO, DCBFCOs and CESM.

Notification of the burn is to be circulated through the WhatsApp group to all Fire Control Officers and the brigade group where the burn will be conducted.

The Shire CEO and DFES ComCen 1800 198 140 are to be notified before the burn can take place.

**Should the yellow bit be included in SOP 1.2 Permits to Burn (refereincing SOP 1.08)? This SOP is about the appointment of the Fire Weather Officer.

RELEVANT INFORMATION	
ADOPTED	NEW SOP – September 2023
REVIEWED	
SOP	1.02 Permits to Set Fire to the Bush
COUNCIL POLICY	2.2 Safety and Health in the Workplace
LEGISLATION	Section 38 <i>Bushfire Act 1954</i>

SOP 1.09 Bush Fire Brigade Volunteers – Minimum Training Requirements

INTRODUCTION

In accordance with Work Health and Safety legislation, the Council has a duty of care to all its brigade volunteers to provide a safe working environment. This extends to ensuring the volunteers responding to a fire incident have received the appropriate training.

Setting minimum requirements for training of volunteers will assist in meeting the Council's obligations for duty of care.

Council Policy 6.2 Bushfire Control Officers and Volunteers defines the minimum training requirements for firefighting volunteers.

POLICY STATEMENT

Volunteer Firefighters:

- (a) All active fire-fighting members of a Shire Brigade must undertake the following training:
 - i. Broomehill East, Broomehill West, Tambellup East and Tambellup West Brigades - the Rural Fire Awareness Course; and
 - ii. Broomehill Central Brigade - the Bushfire Safety Awareness and Firefighting Skills courses
- (b) Recognised Prior Learning (RPL)

A sub-committee consisting of the Chief Bushfire Control Officer and the two (2) Deputy Chief Bushfire Control Officers, be authorised to assess a volunteer fire fighter's competency with regards to the Rural Fire Awareness, Bushfire Safety Awareness and Firefighting Skills and, if satisfied, to recommend to the Shire's CEO that their previous experience be accepted as RPL. All Bush Fire Control Officers should be encouraged to complete the training.
- (c) Effective from 1 October 2023:
 - i. only volunteer fire fighters that have successfully completed or have been RPL assessed for and passed the DFES approved Bushfire Safety Awareness and Firefighting Skills courses are permitted to drive or operate Shire Fire Trucks; and
 - ii. only volunteer firefighters that have recognised RPL for, or passed the DFES approved Rural Fire Awareness course, either in person or online, are eligible to be registered as an active operational (in the field) Shire Volunteer Firefighter.

RELEVANT INFORMATION	
ADOPTED	NEW SOP – September 2023
REVIEWED	
SOP	Nil
COUNCIL POLICY	6.2 Bushfire Control Officers and Volunteers
DELEGATION	Nil
LEGISLATION	<i>Work Health and Safety Act 2020</i>

DRAFT

Section 2: Fire Prevention & Mitigation

DRAFT

SOP 2.01: Fuel Reduction Burns

OBJECTIVE

To ensure that all fuel reduction burns comply with the appropriate legislative and safety requirements.

To provide clear direction to bush fire brigades, the local community and Shire of Broomehill-Tambellup staff in relation to hazard reduction burns on property irrespective of tenure.

STATEMENT

Bushfire brigades play a key role in bush fire management, including risk reduction within their local area. Successfully carried out hazard reduction burns increase the level of protection provided to the local community during fire season.

Bushfire Volunteers are provided with legal protection when operating within the confines of the Bush Fires Act 1954. This protection is extended to hazard reduction burns when they are considered normal brigade activities and approved by the Shire of Broomehill-Tambellup

Brigades are not permitted to charge a fee for service.

Pre-Burning Preparations

Private Property

Private landowners who require the assistance of the bushfire brigade to undertake a hazard reduction burn should contact either the brigade directly, or the Shire's CESM.

Shire of Broomehill-Tambellup Reserves

Requests to conduct a hazard reduction burn on reserves controlled by the Shire of Broomehill-Tambellup should be forwarded to the CEO for approval.

Once a request has been approved, a burn prescription will be developed by the CESM and the relevant brigade will be provided the approval to burn.

A prescription may take up to six months before it is completed and brigades need to factor this into their planning.

Road Verges

Main Roads WA approval is to be obtained prior to burning any road verge under the control of Main Roads WA.

Approval from the CEO of the Shire of Broomehill-Tambellup is to be obtained prior to undertaking any road verge burning on roads managed by the Shire.

The safety of volunteer firefighters is paramount when working along road verges.

Considerations

The CESM will issue a permit for all hazard reduction burns on road verges, after completing due diligence, including Dial Before You Dig, rare flora etc, and will prescribe conditions for burning which must be adhered to.

The Brigade Fire Control Officer (FCO) will coordinate all hazard reduction burns in the brigade area.

When planning and/or undertaking hazard reduction burns the FCO shall consider;

- Breaking the property in to cells for a rotational burning program to reduce the impact on the environment.
- The lighting pattern to be employed with a distinct preference towards cooler burns.
- Notifying the owners of adjoining properties including land owned by the Shire of Broomehill-Tambellup, private landowners, Department of Biodiversity, Conservation and Attractions (DBCA), plantation owners and/or utility companies.
- Assets, including those in adjacent areas, considered at risk from fire.
- Prevailing winds and their effect on the fire and the direction the smoke plume will travel. Particular care needs to be taken when smoke will blow over the road and cause a traffic hazard. See also SOP 4.10 Traffic Management at Bush Fires
- Plans to burn on road verges, or where smoke and/or fire and the presence of emergency vehicles and crew may present a traffic hazard, must include a plan for traffic management.
- Neighbouring brigades should be encouraged to assist with hazard reduction burns.

Before Commencing a Burn

The Brigade FCO is required to ensure they have undertaken a risk assessment for every planned burn. The CESM will develop a prescription for the burn which must be adhered to.

Immediately prior to commencing the burn the FCO must advise the CBFCO, COMCEN, and, if applicable, DBCA, of the burn address and expected duration.

Concluding a Hazard Reduction Burn

The FCO will declare the burn safe when they are satisfied the perimeter of the fire is fully extinguished. In some cases it will be necessary to set up patrol or monitoring arrangements for a period of time following the departure from the fire site.

COMCEN and the CBFCO shall be notified when the hazard reduction burn has concluded.

RELEVANT INFORMATION	
ADOPTED	December 2008
REVIEWED	September 2023
SOP	SOP 1.01 Communications Systems SOP 1.03 Work Health & Safety – Incident/Injury/Hazard Reporting SOP 1.06 Incident Reporting SOP 4.02 Incident Control Systems – AIIMS SOP 4.10 Traffic Management at a Bushfire
COUNCIL POLICY	2.2 Safety & Health in the Workplace 6.4 Roadside Burning
DELEGATION	5.6 Burning of Roadsides
LEGISLATION	<i>Bush Fires Act 1954 s.33; s.34; s38.5A</i> <i>Work Health & Safety Act 2020, Part 2, Division 3, s.22</i>

SOP 2.02: Firebreak Inspections

PURPOSE

To enforce the Shire's annual Firebreak Order.

INTRODUCTION

The Shire has a statutory responsibility to ensure that all landowners and occupiers comply with its annual Fire Break Order.

URBAN LAND (Land within a gazetted townsite)

The Shire's duly authorised officer/s shall commence inspections of all lots within the Broomehill and Tambellup gazetted townsites in October, subject to seasonal conditions. In accordance with the Shire of Broomehill-Tambellup Fire Break Order:

During the period 31 October – 15 April annually, the following measures should be implemented by landowners:

LAND ZONED RESIDENTIAL, TOWN CENTRE, INDUSTRIAL (Townsite land):

On land which is 4000 square metres (1 acre) or less, all flammable material should be removed, except live standing trees.

On land which is 4000 square metres (1 acre) or more in area, clear firebreaks not less than 2 metres completely surrounding and not more than 20 metres from the perimeter of all buildings, haystacks and fuel storage areas situated on the land. The height of all grass on the land is to be less than 150mm in height.

LAND ZONED RURAL RESIDENTIAL/SPECIAL RURAL (Townsite and Suburban areas)

Clear firebreaks not less than 2 metres completely surrounding and not more than 20 metres from the perimeter of all buildings, haystacks and fuel storage areas situated on the land.

Minimise fire hazardous material to the satisfaction of the Chief Fire Control Officer by stocking, slashing or other means. The height of all grass on the land is to be less than 150mm in height.

Following the on-ground inspection, infringements shall be drafted for all non-compliant properties. The Chief Executive Officer shall be briefed regarding non-compliant properties prior to the infringements being forwarded to landowners.

NOTE

Whilst Shire Bush Fire Brigade Volunteers may, at the request of the Shire, assist in inspection procedures they are not empowered to enforce or prosecute in relation to fire control matters. Such transactions shall be the responsibility of the Council and/or its duly authorised officer/s.

RELEVANT INFORMATION	
ADOPTED	December 2008
REVIEWED	September 2023
SOP	Nil
COUNCIL POLICY	Nil
DELEGATION	1.3 Appointment of Authorised Persons 1.4 Enforcement and Legal Proceedings 1.16 Making a Person Comply with a Notice requiring Certain Things to be done on Land 5.4 Firebreaks, Alternative Positions
LEGISLATION	<i>Bush Fires Act 1954 s.33</i>

SOP 2.03: Harvest and Vehicle Movement Bans

PURPOSE

To detail a procedure for the implementation and lifting of Harvest and Vehicle Movement Bans within the district.

INTRODUCTION

As a fire prevention strategy Section 38 of *Bush Fire Regulations 1954* allows for Harvest and Vehicle Movement Bans (HVMB) to be imposed.

The *Bush Fires Act 1954* provides facility for local governments through their FCOs to control burning activities within their gazetted area at different times of the year.

The authority to impose and lift HVMB within the Shire of Broomehill-Tambellup is delegated to the Chief Bush Fire Control Officer and Deputy Chief Bush Fire Control Officers.

The Chief Executive Officer shall be authorised to notify agencies and surrounding Shires as required of any ban imposed.

PROCEDURE

Harvest and Vehicle Movement Bans - Administration

Immediately following the decision to IMPOSE or LIFT a Harvest Ban and/or Movement of Vehicle Ban (clearly ascertain which) the authorised officer shall complete the 'Notification of Harvest Ban' Form (Appendix 2) and forward it to:

RADIO STATIONS

Triple M
ABC Radio

Email

harvestbans@sca.com.au
harvestbans@abc.net.au (see procedure)

SURROUNDING SHIRES

Shire of Gnowangerup
Shire of Katanning
Shire of Kojonup
Shire of Cranbrook

gnpshire@gnowangerup.wa.gov.au
admin@katanning.wa.gov.au
council@kojonup.wa.gov.au
shire@cranbrook.wa.gov.au

HAULAGE CONTRACTORS

Southern Haulage
Matthews Kojonup
Great Southern Fuels

Caltex Link Energy

reception@southernhaulage.com.au
matthewstrans@wn.com.au
julie.hanna@gsfs.com.au
greg.brooks@gsfs.com.au
albany@caltex.com.au

The officer imposing the HVMB shall also:

- update the Shire Harvest Ban Hotline Answering Machine message as per procedure
- send the appropriate Harvest Ban SMS message to registered landowners as per procedures; and

- notify the neighbouring Shire Chief Bush Fire Control Officers via VHF Radio Network or phone.

When a HVMB is reviewed or lifted:

- complete the 'Notification of Harvest Ban' Form and email to surrounding shires and agencies as above;
- the Harvest Ban Hotline will be updated with the appropriate message,
- an SMS message is to be sent to registered landowners advising of the review outcome or lifting of a ban.

THE NOTIFICATION OF THE BAN BEING REVIEWED OR LIFTED IS JUST AS IMPORTANT AS THE NOTIFICATION OF THE BAN BEING IMPOSED.

Documentation relating to the imposing and lifting of a HVMB must be forwarded to the Shire for recording into the Shire's records system.

NON-COMPLIANCE

Any instances of non-compliance with a Harvest Ban within the Shire must be reported to the CEO or the Chief Bush Fire Control Officer.

PROSECUTION

People conducting unauthorised activities during a Harvest Ban will be liable for prosecution.

The Council and/or its duly authorised officer shall retain responsibility for all transactions relating to the enforcement or prosecution of offences relating to fire control matters.

RELEVANT INFORMATION	
ADOPTED	December 2008
REVIEWED	September 2023
SOP	Nil
COUNCIL POLICY	Nil
DELEGATION	1.4 Enforcement and Legal Proceedings 5.7 Taking Proceedings for Offences, Bush Fires Act
LEGISLATION	<i>Bush Fires Act 1954 Part III Div 6</i> <i>Bush Fire Regulations 1954 s.38A</i>

Appendix 4: Harvest Ban Notification Form



NOTICE OF HARVESTING AND/OR VEHICLE MOVEMENT BAN

The Shire of Broomehill-Tambellup has imposed a ban on Harvesting and/or the Movement of Vehicles in paddocks.

The ban is effective from am/pm on (date)

The ban will be reviewed at am/pm on (date)

The ban will be lifted at am/pm on (date)

The ban will remain in place until further notice.

Harvest Ban Hotline - 9825 1042

.....

Name

Position (CEO/CBFCO/CESM)

.....
Date

.....
Time:

Section 3: Call Out and Mobilisation

DRAFT

SOP 3.01: Incident Announcement

PURPOSE

- To provide Brigades with a standard method for the announcement of fire calls.
- To provide for efficient identification and dispatching of resources to an incident.

INTRODUCTION

When an emergency turnout is announced, a standard format should be used so that the recipients become familiar with the method used to deliver the call and the information required to attend the incident is given in a clear concise manner.

Calls may be received directly from members of the public, or through the '000' service. The CBFCO, CESM and Shire CEO are registered to receive calls through the '000' service.

CALL RECEIPT

- The Fire Control Officer, CESM, or CEO receives the call.
- The caller is questioned to determine the location and type of incident.
- The information received is dispatched to the CBFCO
- The nearest Brigade for the incident is determined.
- The relevant brigade is mobilised to the incident. All brigades are registered with the Shire's SMS system. The CBFCO or CESM will send turn out message to the relevant brigade/s with details of incident, initially through the Brigade WhatsApp, then by SMS through the Shire's SMS system.
- CBFCO is to contact DFES COMCEN on 1800 198 140 advising of brigade activation for all incidents. COMCEN will create an incident number for noting on the Fire Incident Report form. (See Appendix 1 – Incident Report Forms)

DISPATCH METHOD

- CBFCO mobilises the required resources as per the above.
- **On notification of mobilisation:** Brigade members shall advise the CBFCO of estimated time of arrival (ETA) at incident by radio or phone.
- **The CBFCO shall advise brigade members who the Incident Controller is on site.**
- **On arrival at incident site:** wherever possible, Brigade members shall advise the Incident Controller on site of their arrival by radio or in person.
- **As soon as is practicable:** the Incident Controller will provide details to the CBFCO such as location and direction of fire, entry points, fuel loadings, weather conditions and estimated number of units present, further units required and location of water refill site.
- **Consideration should be given after assessment as to whether a Bushfire Warning should be issued. This is done by the CESM or the Regional Duty Coordinator.**
- **Within 30 minutes of arrival:** the Incident Controller will provide updated details to CBFCO as outlined above.
- **When the incident is resolved:** The Incident Controller shall notify CBFCO when the incident is resolved.
- CBFCO to notify DFES COMCEN on 1800 198 140 of Brigade stand down.

AGENCY NOTIFICATION

Where the Shire is the Controlling Agency at an incident, the CBFCO shall notify the following:

- CESM
- Shire of Broomehill-Tambellup office
- DFES Communications Centre – 1800 198 140
- Tambellup Police (If roads will be impacted and traffic management or road closure is required)
- Tambellup or Katanning St John Ambulance (If the incident is complex)

RELEVANT INFORMATION	
ADOPTED	December 2008
REVIEWED	September 2023
SOP	SOP 1.01 Communications Systems SOP 1.06 Brigade Incident Reporting SOP 3.02 Bushfire Warning System
COUNCIL POLICY	Nil
LEGISLATION	<i>Fire Brigades Act 1942 s.34</i> <i>Bush Fires Act 1954 Part IV</i>

SOP 3.02: Bushfire Warning System

PURPOSE

To provide clarification on DFES bushfire warning system levels.

STATEMENT

During a bushfire, DFES, under instruction from the Shire and DBCA, issues community alerts and warnings for bushfires that threaten lives and property. They are issued once firefighters have arrived at the scene and determine that there is a threat or potential threat to the community.

Understanding the Bushfire Warning System is extremely important in helping you and your family to stay alert and informed when a bushfire starts.

In 2022 DFES adopted the Australian Warning System standard, incorporating updated icons for all hazards on the Emergency WA website (www.emergencywa.gov.au):



EMERGENCY WARNING

There is a threat to lives or homes.

You are in danger and need to take immediate action to survive.



WATCH AND ACT

There is a possible threat to lives or homes.

You need to leave or get ready to defend – do not wait and see.



ADVICE

A fire has started but there is no immediate threat to lives or homes.

Be aware and keep up to date.

Where can I get information during an emergency?

 emergency.wa.gov.au  13 DFES (13 33 37)

 @dfeswa  @dfes_wa  Local ABC Radio

These levels change to reflect the increasing risk to life or property and decreasing amount of time before the fire arrives.

On arrival at an incident site, and on assessment of the incident, the Incident Controller in consultation with the CBFCO should consider whether a Bushfire Warning should be issued. If a Warning is to be issued, the CBFCO should contact the CESM or Regional Duty Coordinator on 1800 314644.

Similarly, if it is considered during the course of the incident that the risk level has lessened, the CESM or Regional Duty Coordinator should be requested to downgrade the Warning.

RELEVANT INFORMATION	
ADOPTED	December 2020
REVIEWED	September 2023
SOP	SOP 1.01 Communications Systems SOP 3.01 Incident Announcement
COUNCIL POLICY	Nil
LEGISLATION	<i>Fire Brigades Act 1942 s.34</i> <i>Bush Fires Act 1954 Part IV</i>

SOP 3.03: Fire Appliances Outside Municipality Boundaries

PURPOSE

To provide a procedure for the deployment of Shire resources outside the Shire of Broomehill-Tambellup.

INTRODUCTION

The Shire of Broomehill-Tambellup Bushfire Brigade appliances are primarily intended for use in fire suppression and control within the municipality's boundaries. Notwithstanding, there will be occasions where the Brigade fire vehicle and volunteer crew will be requested to attend and assist with fire suppression in neighbouring Shires. This support is provided at the discretion of the Shire of Broomehill-Tambellup.

APPROVAL CONSIDERATIONS

Approval should be obtained from the Chief Executive Officer (via the CBFCO or CESM) prior to deployment of any Shire appliance to incidents outside the Shire of Broomehill-Tambellup

Prior to granting approval the authorising officer shall have regard to the following:

- The appliance shall not be required within the Broomehill or Tambellup district at that time.
- The deployment of the appliance shall not decrease response capabilities to fires in the Broomehill or Tambellup district.
- There are brigade members available to crew the appliance.
- The period of time that the appliance will be required.
- Arrangements for shift changes for personnel crewing the appliance.
- Crews are suitably experienced to attend the incident-type.
- Brigade appliances are not to travel outside the Shire boundary except to attend fires.

RELEVANT INFORMATION	
ADOPTED	December 2008
REVIEWED	September 2023
SOP	Nil
COUNCIL POLICY	2.2 Safety & Health in the Workplace
LEGISLATION	<i>Bush Fires Act 1954</i> <i>Work Health & Safety Act 2020, Part 2, Division 3, s.22</i>

Section 4: Incident Control and Response

DRAFT

SOP 4.01: Wildfire Operational Management

PURPOSE

To ensure that appropriate management procedures are adopted during wildfires.

INTRODUCTION

This Standard Operational Procedure is to provide Incident Controllers in charge of wildfires guidance on safe and effective operations. Whilst safe and effective operations cannot be guaranteed, it is in the interests of the Incident Controller to gather incident information, and interpret that information in a manner that will ensure that safety considerations are, or have been taken into account.

MANAGEMENT METHOD

- Approach the incident from the safest known available direction and conduct a size up.
- Brief crews with known details of the incident call.
- The officer in charge of the first arriving appliance, or a Brigade Radio Operator shall assume control until a more senior Brigade Officer arrives on site. The Brigade Officer shall assume the role of Incident Controller.
- Consider sectorising and how many sectors are required.
- Allocate on ground UHF radio channels to suit sectorising arrangement
- Consider setting up a forward control point for incoming appliances.
- Provide a Situation Report (SitRep) to the CBFCO including:
 - Incident location
 - Fire spread and direction
 - Fire ground entry points
 - Fuel loadings
 - Weather conditions
 - Estimated appliances required
 - Location of water refill sites
- Determine if any persons are in danger and protect or evacuate to a safe location.
- Determine if any property is in danger and what can be done to safely protect it.
- Determine if Bushfire Warnings are required to be issued
- Identify a secure supply of water to support firefighting operations. Local knowledge is a key factor in considering water supplies and whether early mobilisation of water tankers are required
- Spot weather forecasts can be obtained by contacting the CESM, or the Regional Duty Coordinator on 1800 314 644.
- Consider the use of heavy equipment or water bombing to assist in the strategic containment or suppression of the fire. Contact the CESM on 0417 071 567 or the Regional Duty Coordinator on 1800 314 644 if this support is required.
- Continue to provide SitReps as initiated to CBFCO or as required.
- Conduct mop up and black out activities to make the fire safe.

CHIEF BUSH FIRE CONTROL OFFICER

Where the Shire is the Controlling Agency at an incident, the CBFCO shall provide SitRep information to the following as required:

AUTHORITY	CONTACT
Community Emergency Services Manager (CESM)	0417 071 567
DFES Regional Duty Coordinator	1800 314 644
If fire is on DBCA land: Department of Biodiversity, Conservation and Attractions - Albany	9842 4500
Tambellup Police	9854 9800 or 000
Tambellup St John Ambulance	000
Katanning St John Ambulance	000
Chief Executive Officer	0434 019 990

SUPPORT AND EXPENSE REIMBURSEMENT

Contact DFES Regional Duty Coordinator early in the incident for ongoing support and authorisation for expense reimbursement. Retrospective authorisation cannot be made.

If the fire is on DBCA land contact the Albany office early in the incident for support and authorisation for expense reimbursement.

RELEVANT INFORMATION	
ADOPTED	December 2008
REVIEWED	September 2023
SOP	SOP 1.01 Communications Systems SOP 1.05 Shire Owned Equipment at a Wildfire SOP 3.01 Incident Announcement SOP 4.02 Incident Control Systems – AIIMS SOP 4.08 Incident Escalation SOP 4.09 Transfer of Incident Control - Interagency
COUNCIL POLICY	4.9 Shire Owned Equipment at a Wildfire
DELEGATION	5.8 Handover of Control of Bushfires
LEGISLATION	<i>Fire Brigades Act 1942 s.34</i> <i>Bush Fires Act 1954 Part IV</i>

SOP 4.02: Incident Control System - AIIMS

PURPOSE

To provide Brigades with a system of command, control and coordination at incidents.

INTRODUCTION

All fire incidents no matter how large or small are more efficiently and effectively handled when they are well managed. In reality this means that during all fire incidents that occur, someone must assume control and devote their time and energy to managing the situation.

The Shire of Broomehill-Tambellup recognizes the Australian Interservice Incident Management System (AIIMS) as best practice and supports its implementation at incidents. Training of fire brigade members is required to ensure the system is understood and applied at incidents.

SHIRE SPECIFIC ROLES

A rough guide to AIIMS roles in a Level 1 fire shall be as follows:

ICS FUNCTION	OFFICER
Incident Controller /Operations Officer	Brigade FCO on site
Logistics Officer	Shire Administration
Planning Officer	DFES
Public Information Officer	Shire President/CEO

The CBFCO and/or DCBFCO will provide support to the Incident Controller on site or remotely as required.

PROPOSED AIIMS METHOD

Upon arrival at a fire incident, the Officer in Charge of the first arriving crew will assume responsibility as Incident Controller until relieved if required by an officer from the agency responsible for the fire. The relieving officer may be a DBCA officer, a DFES officer or a more senior Bushfire Brigade Officer.

The Incident Controller is to ensure that all the following areas are considered when an incident is active:

1. A reconnaissance of the incident site is conducted to:
 - Determine the appropriate control structure.
 - Determine the operational requirements.
 - Determine the communication requirements.
 - Identify the extent and predict the likely spread of the incident.
 - Determine if a Bushfire Warning is required to issued
2. Delegate designated positions to capable personnel.
3. Ensure that Incident Control Plans are in place.
4. Briefings are to be carried out when changing over personnel.
5. Consider scaling the incident up if the incident size and impact increases and consider scaling the incident down if the incident size and impact reduces.

The provision of an Incident Report is the responsibility of the Incident Controller and the responsible Controlling Agency i.e. Shire of Broomehill-Tambellup. A report should be provided to the CESM, who will forward to the Shire and DFES Great Southern Regional Office.

Understandably, the size of the fire and the amount of resources involved will dictate the size of the AIIMS management structure, which is entirely flexible. The AIIMS structure may be no more than a FCO with a map on the bonnet of his vehicle.

NOTE

The Incident Controller is to take all reasonable steps to ensure the safety of all personnel. Where the size of the fire incident so dictates, Brigades should request assistance from the Shire of Broomehill-Tambellup or DFES Great Southern Regional Office to establish and maintain an AIIMS structure for a fire incident.

RELEVANT INFORMATION	
ADOPTED	December 2008
REVIEWED	September 2023
SOP	SOP 1.01 Communications Systems SOP 1.06 Brigade Incident Reporting SOP 3.02 Bushfire Warning System SOP 4.08 Incident Escalation SOP 4.09 Transfer of Incident Control - Interagency
COUNCIL POLICY	Nil
LEGISLATION	<i>Fire Brigades Act 1942 s.34</i> <i>Bush Fires Act 1954 s.44</i>

SOP 4.03: Traffic Management at Bushfires

PURPOSE

To provide instruction to Incident Controllers on the procedure to be undertaken when traffic management and/or road closures are necessary to assist with wildfire suppression.

INTRODUCTION

Any person with authority to act under various Emergency Services Legislation and Acts, can erect portable road signs and manage traffic in order to provide for the safety and welfare of themselves, their emergency workers and members of the public during emergency incidents occurring on, or near roads.

AUTHORITY TO CLOSE ROADS

The *Bush Fires Act 1954* provides the authority for a Bush Fire Brigade member in control of a bushfire (the Incident Controller) to close roads where there is a risk to the public or to fire fighters.

The Incident Controller is responsible for closing roads, the welfare of emergency responders, and the welfare of road users at Vehicle Control Points.

DFES Communications Centre (Comcen - 1800 198 140) can arrange for Police and Main Roads assistance. Clearly describe the situation as '*traffic control to protect emergency personnel*' will be a higher priority than a general request to manage traffic. A 'Request for WA Police Assistance' form must be completed as soon as practical.

Please note:

Main Roads WA (138 138) must be informed when State Roads are closed. This can also be done through DFES Comcen (1800 198 140).

TRAFFIC MANAGEMENT AT ROADSIDE FIRE EMERGENCIES

Visibility

To maximise the visibility of crew and appliances, all crew must wear full PPE. All appliance beacons and hazard lights should be operating throughout the roadside emergency.

Crew members not directly involved should be off the road, and clear of the incident scene and general flow of traffic.

As soon as traffic has been assessed as a hazard, portable hazard signs (fold-up tripods, traffic cones or similar) should be positioned in proximity to the incident or work area.

- Signs are positioned on both traffic approaches where possible so hazards are clearly visible to approaching traffic.
- Ensure adequate line of sight to allow large vehicles to stop.
- Line of sight distances for oncoming traffic are:
 - 60km/hr or lower speed zone – 150m or more
 - Elsewhere – 250m or more
- Consider the need for large vehicles to be able to turn around.
- Take account of the immediate environment when placing signage – shade, weather, existing speed signs and advertising signs that may obscure or confuse the warning.

- Avoid locating signage where drivers are required to concentrate on other road hazards, eg on bends, bridges, railway crossings etc.
- Ensure signs are not positioned where they may become a traffic hazard to motorists.

Note. S = maximum road speed limit in the area e.g. 80kmh = 2 X 80 = 160m. Cones are to be spaced 6m apart.

ROAD TRAFFIC WARNING SIGNAGE – DIAGRAMS

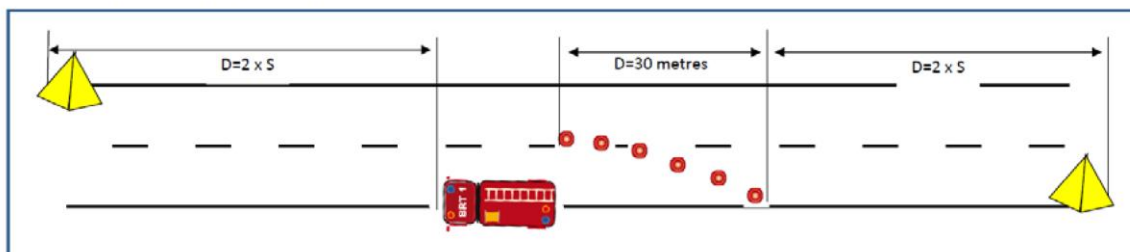

Figure 1 – Road Traffic Control Signs in Support of General Emergency Roadway Setup

ROAD CLOSURES

Vehicle Control Points

Vehicle Control Points (VCPs) are the last line of incident site control, and for this reason, they must be permanently staffed. Staff at VCPs must have radio communications with the Incident Controller or Incident Management Team at all times.

Shire staff are able to provide traffic management at VCPs. Requests for support must be directed to the CEO.

Personnel are not to endanger their lives in attempting to stop vehicles. Traffic controllers confronted by a road user's intent on breaching closures should warn the driver that:

- Passing the road closure could lead to danger;
- Breaching the road closure is an offence; and
- The vehicle and drivers description will be reported immediately, information includes:
 - Time/date; Description of vehicle/driver; Registration; Actions; Witness names.

As calls to DFES Comcen are recorded, it is recommended that Comcen is contacted as soon as possible to provide the above information with a request for WA Police to follow up.

Full Road Closure

Access beyond a full road closure VCP can only be authorised by the Incident Controller and typically involves vehicles from the controlling agency, a combat agency and support organisations. In addition the Incident Controller may give permission for a designated vehicle or person to proceed beyond a VCP.

The Incident Controller must provide clear direction to WA Police or traffic controllers on which vehicles are permitted through a road closure, to minimise the risk of fire fighters being delayed. Examples:

- 'Firefighting units (including farm units), vehicles with triangle identification stickers on windscreen and volunteer fire fighters are permitted through.'
- 'No one, including fire fighters, is permitted through due to damaged bridge.'

Partial Road Closure

Partial road closures may be realised through lane control measures.

In some cases an Incident Controller may allow restricted access. Such situations may arise from residents returning home to check property for damage, to salvage their possessions, to deliver relief to residents or their stock, and for essential service crews.

Protracted Duration Emergency

If the incident is likely to be prolonged (more than 4 hours) the Incident Controller needs to ensure WA Police or traffic management contractors are in place. Under these circumstances it is important for communications to be maintained between the Incident Controller and traffic management authorities.

The welfare of people affected by short term road closures remains the responsibility of the controlling agency in consultation with Department of Communities. Extended closures will require a more active involvement by Department of Communities who may need to organise and coordinate the provision of welfare centres.

Detours

Traffic must not be detoured unless part of an approved Traffic Management Plan. This recognises the risk of directing vehicles onto roads that are unsuitable/unsafe including the unknown capability of drivers. The Incident Controller should consult with relevant authorities to determine suitable detour routes.

Evacuation of Affected People

Selection of suitable evacuation routes and allowing unrestricted egress from incidents is also a consideration of any traffic management plan at an incident. Designated evacuation routes should be for one way traffic only, apart from emergency vehicles that may be attending the scene which may also use the same route.

Public Information

If road closures are required to be initiated, the Incident Controller should request (through the CBFCO/CESM) for an SMS to be broadcast to all registered contacts advising details of the closure.

The Incident Controller should consider the release of public warnings through the DFES Bushfire Warning System (see SOP 3.02 Bushfire Warning System) especially if the road is, or is likely to be, impacted by smoke and/or fire and/or the incident will be of a protracted duration. Warnings can be issued by the CESM or Regional Duty Coordinator.

While the Incident Controller has authority to partially/totally close a road during fire emergency situations they have no authority to direct and divert traffic via alternative routes. This authority remains with Main Roads or Local Government.

Record Keeping

All critical decisions and requests relating to traffic management and/or road closure must be recorded in the incident log.

Vehicle Control Points need to be clearly identified and the location agreed to by the Incident Controller. VCP locations must be recorded and signed off by the Incident Controller.

Re-opening of Roads

The Incident Controller cannot open the road. The Incident Controller must be satisfied that the incident is no longer a threat before handing the road back to the road owner (Local Government or Main Roads WA) who will assess the road condition before deciding to open the road.

All traffic management signs must be removed as soon as possible after the roads have re-opened.

RELEVANT INFORMATION	
ADOPTED	December 2020
REVIEWED	September 2023
SOP	SOP 1.01 Communications Systems SOP 1.03 Work Health & Safety – Incident/Injury/Hazard Reporting SOP 3.02 Bushfire Warning System SOP 4.01 Wildfire Operational Management SOP 4.02 Incident Control Systems - AIIMS
COUNCIL POLICY	2.2 Safety & Health in the Workplace
LEGISLATION	<i>Work Health & Safety Act 2020, Part 2, Division 3, s.22</i> <i>Fire Brigades Act 1942 s.34</i> <i>Bush Fires Act 1954 s.39.1; s.44</i> <i>Emergency Management Act 2005 s.67</i>

SOP 4.04: Entrapment at a Bushfire – Burnover Procedure

PURPOSE

To provide a standard procedure to ensure the safety of firefighters entrapped by an encroaching bushfire and subject to a likely burnover of their appliance.

INTRODUCTION

An outcome from the investigation of the 2012 Black Cat Creek incident is that all formal Local Government and DFES appliances should be fitted with burnover blankets appropriate to the number of seated positions, Water Deluge System, In Cab Air and Automatic Vehicle Locator (AVL), and volunteers should be trained in the use of the above protection equipment.

The Broomehill Central Brigade appliance has been fitted with the above equipment.

PROCEDURE

When preparing for entrapment at a bushfire:

- Ensure crews are initially briefed on the task and risks.
- Ensure crews remain aware of the current and forecast situation.
- Appliances will maintain 25% water reserves on appliances for personal protection.
- Undertake suppression tasks with the due reference to LACES:
L – Lookouts
A – Awareness
C – Communication
E – Escape Routes
S – Safety Zones
- Ensure all crew understand the concept of the '*dead man zone*'.
- Activate the EMERGENCY AVL BUTTON as per training.
- Transmit 'EMERGENCY MESSAGE' via radio.
- Activate beacons/emergency warning devices and siren.
- Notify Incident Controller of the location and situation.
- Request aerial assistance (water bomber/helitacs) if available.
- Branch operators are to close down all branches and place them on the ground. All crews are to return to the vehicle.
- Locate first aid kit and place inside cab.
- Close down and remove the delivery lines at the pump
- Park appliance on burn/cleared area in a position that affords as much protection as possible for the crew (e.g. rear of the appliance facing the fire front).
- Close all doors, windows and air vents and leave the engine running on fast idle.
- Conduct a head count to ensure all the crew are present and mount the appliance.
- Take cover in the cabin. Activate Water Deluge System from inside the appliance.
- Dress in full PPE. Activate the In Cab Air as per training.
- Crew to cover with blanket/protection.
- **STAY INSIDE THE VEHICLE.**
- Wait for the fire front to pass. Immediately after the fire front has passed, account for all the crew and check the vehicle for damage.

- **NOTE** – Do not hose down crew members' with water prior to the fire front passing as the conduction of heat through the clothing may induce steam burns.

WHAT TO EXPECT

As the fire front approaches, the intensity of the heat will increase along with the amount of smoke and ember. Radiated heat will transfer directly to inside the cabin.

- Smoke gradually gets inside the vehicle and fumes will be released from the interior of the appliance.
- Stay as close to the floor as possible.

Fuel tanks are very unlikely to explode. Fuel jerry cans and drip torches not fitted with anti-explosive mesh may however be at risk. These should be removed and placed at a distance from the appliance.

AFTER THE FIRE FRONT HAS PASSED

Stay in the vehicle until the fire front has passed and the temperature has dropped outside.

- Once the fire front has passed and the temperature has dropped cautiously exit the vehicle. Be careful – internal parts will be extremely hot.
- Take portable radios (VHF and UHF)
- Take first aid kits and oxy-viva (if part of the stowage)
- Move to a safe area
- Stay covered in PPE and blankets, continue to drink water and await assistance.
- Send a SitRep to the Incident Controller, if possible.

RELEVANT INFORMATION	
ADOPTED	August 2014
REVIEWED	September 2023
SOP	SOP 1.01 Communications Systems SOP 1.03 Work Health & Safety – Incident/Injury/Hazard Reporting SOP 4.02 Incident Control System - AIIMS SOP 5.01 Personal Protective Equipment SOP 5.06 Burnover Blankets SOP 6.02 Automatic Vehicle Locator
COUNCIL POLICY	2.2 Safety & Health in the Workplace
LEGISLATION	Work Health & Safety Act 2020, Part 2, Division 3, s.22

SOP 4.05: Red Flag Warning

PURPOSE

To provide a standard procedure for firefighters for the red flag warning.

INTRODUCTION

Incident experience across Australia, in particular during major bushfires, has shown that a lack of access to timely and critical information by personnel at an incident has led to injuries and fatalities. Red Flag Warnings are a message system that provides a process to ensure critical information (such as fire weather changes) is confirmed as received to the lowest levels and understood by all personnel at the incident.

PRINCIPLES

Red Flag Warnings are to be precise messages which convey present or impending hazards to emergency responders, outside the normal shift or deployment briefings, e.g. weather changes, hazardous materials, fire behaviour, structural integrity, equipment failures etc.

- Red Flag Warnings are to be initiated within the command hierarchy.
- Red Flag Warnings must be passed to all personnel at the incident, including those from other agencies or private contractors.
- At all levels, red flag warnings are to be acknowledged on receipt through confirmation of the message back to the sender.
- The transmission, receipt and acknowledgements of Red Flag Warnings are to be logged.

PROCEDURE

The standard message text of a Red Flag Warning is as follows:

'RED FLAG WARNING. Personnel are advised of *<actual/forecast where appropriate>* conditions that may present a hazard to personnel as follows *<actual/forecast conditions>*. Personnel are to *<describe specific actions required to be taken>*. This message is to be passed on to all personnel under your command

ACKNOWLEDGE'

RECORDING, RECEIPT & ACKNOWLEDGEMENT

- All Red Flag Warnings issued through the incident chain of command are to be recorded in incident diaries.

RELEVANT INFORMATION	
ADOPTED	August 2014
REVIEWED	September 2023
SOP	SOP 1.01 Communications Systems SOP 1.03 Work Health & Safety – Incident/Injury/Hazard Reporting SOP 4.01 Wildfire Operational Management SOP 4.02 Incident Control Systems – AIIMS
COUNCIL POLICY	2.2 Safety & Health in the Workplace
LEGISLATION	<i>Work Health & Safety Act 2020, Part 2, Division 3, s.22</i>

SOP 4.06: Brigades Responding to Fires that may be Suspicious

The priority of fire crews will always be extinguishing the blaze, saving life, property and environment. This should always be the priority. The preservation of what may be the crime scene will always come in under this.

There is no expectation from police that they want volunteers or DFES staff to turn into crime scene experts but will be extremely grateful for any assistance that can be provided in preserving the scene until police arrive.

ON THE WAY TO THE FIRE

Take note of vehicles and people you see – time, vehicle registration, description, direction of travel.

ON ARRIVAL AND FIRE CREW OBSERVATIONS

- Do not let people into the incident area.
- Minimise resources required to gain control over the entire scene.
- Are there people in the immediate area – what are they wearing, carrying?
- Even if it seems irrelevant note it anyway.
- Secure the area around tyre marks, shoe impression, gate / fencing entry cuts, etc.
- Where was the fire most intense on arrival?
- Was there more than one ignition point?

TAPE OFF AND SECURE SCENE

In consideration of establishing a crime scene before police arrive, Police would like the obvious fire area where the fire occurred, and double that area taped off. This will be the crime scene, not always possible but desirable.

If onlookers give you information write it down and record their names as they may leave the area before the police arrive.

If possible have someone wait on site until police arrive so the scene stays secure.

RELEVANT INFORMATION	
ADOPTED	October 2015
REVIEWED	September 2023
SOP	SOP 3.01 Incident Announcement SOP 4.01 Wildfire Operational Management
COUNCIL POLICY	Nil
LEGISLATION	<i>Bush Fires Act 1954 Part IV</i>

SOP 4.07: Use of 'Class A' Foam

INTRODUCTION

The use of Class A foam can enhance the effectiveness of firefighting operations.

APPLICATION RATIO

Foam is supplied in concentrated form and must be mixed with water and aspirated for use. As a guide, the recommended mix ration is up to 0.03% concentration for bush firefighting operations (equates to approximately one cup of concentrate to 2,000 litres of water).

ENVIRONMENTAL CONSIDERATIONS

The use of foam can pose environmental risk to waterways, some agricultural operations and some fauna. The IC is to ensure Dept. Water & Environment Regulation (DWER) is notified if foam enters a water body.

The following factors should be taken into consideration by the IC before authorising the use of foam:

- Protection of domestic water supplies: Domestic water storages contaminated with foam or wetting agents are to be flushed before re-use.
- Protection of aquatic environments: All possible care is to be taken to ensure that foam does not enter water bodies.
- Protection of agricultural interests: Care should be taken when using foam near agricultural operation to ensure that the foam does not contaminate crops or produce.

SAFETY PRECAUTIONS

Safety considerations and guidance for operators using A Class foam concentrate and suppressants are as follow.

- All personnel are to adhere to the manufacturer's guidance as detailed on the product MSDS provided at delivery.
- Avoid inhalation of foam vapours. Decant foam concentrate in well-ventilated areas.
- Avoid ingestion of foam concentrate.
- Foam concentrate, and to a lesser degree foam solution, can be harmful. If ingestion occurs, seek IMMEDIATE medical attention.
- Wear Level 1 PPE, gloves and goggles where the risk of contamination exists (e.g. decanting)
- Wipe up any spilt concentrate
- In the event of personnel coming into contact with foam concentrate:
 - Eyes or skin - immediately flush with clean water and seek medical assistance if required.
 - Soaked clothing - remove and flush with copious amounts of water as soon as possible.
 - If any side effects occur from exposure to the foam concentrates (i.e. dry red itchy skin) seek medical advice
- Dispose of all used foam containers in an environmentally responsible manner.

CLEAN UP

As the foam concentrate is corrosive and will cause damage to equipment all firefighting appliances and equipment used with foam are to be thoroughly flushed with clean water after use.

RELEVANT INFORMATION	
ADOPTED	December 2020
REVIEWED	September 2023
SOP	SOP 1.03 Work Health & Safety – Incident/Injury/Hazard Reporting SOP 6.01 Fire Appliances - Maintenance and Modification
COUNCIL POLICY	2.2 Safety & Health in the Workplace
LEGISLATION	<i>Work Health & Safety Act 2020, Part 2, Division 3, s.22</i>

SOP 4.08: Incident Escalation

INCIDENT LEVELS

The State Emergency Management Committee (SEMC) has defined three operational levels that are to be used to classify the severity of incidents.

A **Level 1 fire incident** is characterised by being able to be controlled through local or initial response resources within a few hours of notification. Being relatively minor, all functions of incident management are generally undertaken by the first arriving crew/s.

Level 2 fire incidents are more complex either in size, duration, resources, risk or community impact. They usually require delegation of a number of incident management functions and may require interagency response.

Level 3 fire incidents are protracted, large and resource intensive. They may affect community assets and/or critical infrastructure and attract significant community, media and political interest. These incidents will usually involve delegation of all the Incident Management functions.

ASSESSING THE INCIDENT LEVEL

An assessment of the incident should be undertaken as soon as possible after attendance to determine if further assistance is required. An incident is initially defined as a Level 1 incident unless:

- a) the Incident Controller (IC) determines otherwise; and
- b) an incident level declaration is made.

The majority of fires attended by Shire of Broomehill-Tambellup Bush Fire Brigades are Level 1 incidents. As Level 1 is the default incident level, it is not necessary to fill in an Incident Level Declaration.

Level 1 classifications cover a range of incident sizes and complexities and which can require different skill levels to manage. ICs can access additional resources or expertise as required through DFES.

Larger, slightly more complex, Level 1 incidents may require the appointment of a qualified Level 1 Incident Controller. This can be initiated at the request of the current IC, as an offer by the CBFCO or, in some cases, at the direction of the CBFCO.

MONITORING THE INCIDENT

The incident is to be continually monitored, and assessed, by the IC to ensure changes are identified and the incident level escalated or de-escalated, as necessary. The escalation of an incident is at the discretion of the Incident Controller.

The IC will note the declared incident level in the IC's incident log and all Situation Reports sent through the command line.

If it is possible an incident may escalate to Level 2 the DFES Regional Duty Coordinator must be notified to alert them to this possibility.

INCIDENT LEVEL ESCALATION

If the bush fire conditions warrant an escalation to Level 2, DFES, as the Hazard Management Agency for fire, must be advised.

At the declaration of a Level 2 Incident, the IC will:

- a) complete an Incident Level Declaration form (available from the CESM)
- b) communicate the Level 2 declaration to the CBFCO (or delegate) and to the CEO.

INCIDENT HANDOVER

Under the Bush Fires Act 1954 the IC can request control of the incident be handed over to DFES or DBCA. This should be done in consultation with the Chief Bush Fire Control Officer (or delegate).

LEVEL 3 INCIDENT

Shire of Broomehill-Tambellup Bush Fire Brigades will only be providing combat resources or AIIMS Incident Management Team support to DFES for Level 3 incidents.

RELEVANT INFORMATION	
ADOPTED	December 2020
REVIEWED	September 2023
SOP	SOP 4.01 Wildfire Operational Management SOP 4.02 Incident Control Systems – AIIMS SOP 4.09 Transfer of Incident Control - Interagency
COUNCIL POLICY	Nil
DELEGATION	5.8 Handover of Control of Bushfires
LEGISLATION	<i>Emergency Management Act 2005</i> <i>Emergency Management Regulations 2006</i> <i>Bush Fires Act 1954</i>

SOP 4.09: Transfer of Incident Control – Interagency

INTRODUCTION

Under the *Bush Fires Act 1954*, a local government Fire Control Officer may request that the incident control of a fire be transferred to Department of Biodiversity & Conservation (DBCA) or Department of Fire and Emergency Services (DFES).

The existing Incident Controller (IC) is to consult with the Chief Bush Fire Control Officer when considering handing over the control of a fire to another agency.

HANDOVER BRIEFINGS

Where the control of an incident is handed to another agency, the current IC must conduct a formal handover to the incoming IC using the standard **SMEACS** (Situation, Mission, Execution, Administration & Logistics, Command & Communication, Safety) format (refer Appendix 3 SMEACS Checklist).

Transfer of Control between the Shire of Broomehill-Tambellup and DBCA:

Under Section 45(a) of the *Bush Fires Act 1954*, control of bush fires may be transferred between Local Governments and DBCA at any time after considering which agency is best placed or resourced to deal with the emergency.

The request for transfer of control to DBCA should be made by the CBFCO (or delegate) to the DBCA Duty Officer. The request can be verbal but the request for handover must be noted in the incident log. The outcome of the request must also be recorded in the incident log.

The current IC must notify the DFES Duty Officer or COMCEN and all other personnel involved in the incident of the handover.

Transfer of Control to DFES:

An IC may request DFES to assume control of the incident under Section 13(4)(a) of the *Bush Fires Act 1954*.

The request for transfer of control should be made by the CBFCO (or delegate) to the DFES Duty Officer. The request can be verbal but the request for handover must be noted in the incident log. The outcome of the request must also be recorded in the incident log.

The current IC must notify all other personnel involved in the incident of the handover.

Transfer of Control from DBCA or DFES to the Shire of Broomehill-Tambellup:

DFES or DBCA may request that incident control of a fire to be transferred to the Shire. This request should be made to the CBFCO (or delegate) who will determine if the Shire is suitably placed to accept the transfer of control.

The IC must notify all other personnel involved in the incident of the handover.

RELEVANT INFORMATION	
ADOPTED	December 2020
REVIEWED	September 2023
SOP	SOP 4.01 Wildfire Operational Management SOP 4.02 Incident Control Systems – AIIMS SOP 4.08 Incident Escalation
COUNCIL POLICY	Nil
DELEGATION	5.8 Handover of Control of Bushfires
LEGISLATION	<i>Bush Fires Act 1954 s13.4(a); s45(a)</i>

Appendix 5: SMEACS Checklist

SMEACS BRIEFING CHECKLIST AIIMS - 2.2 / V1.0

Operation Period Fm: – To:	Incident Name:	Inc / OCN #:	Date Prepared	Time Prepared	Prepared by:	Sector:
BRIEFING PRELIMINARIES: <ul style="list-style-type: none"> Decide type of briefing, e.g. overview, delegation, changeover Identify relevant briefing points from checklist. 			<ul style="list-style-type: none"> Introduce yourself Outline the purpose of the briefing Set the rules of the briefing 			

S – SITUATION *Overview of the Situation*

History	
Current Situation	
Predicted Situation	
Values at Risk	
Forecast Weather	
Current Weather	
Resource Deployment	

M - MISSION

Incident Objectives	
---------------------	--

E – EXECUTION

Divisions & Sectors	
Strategies for each Incident Objective	
Tactics	
Task & Resource Allocation	
Authority to Act – Responsibilities	
Known Hazards	
Welfare Requirements	
Part to play for those receiving briefing	
Implications of not achieving work targets	
Dress requirements (including PPE)	
Time constraints & deadlines	

A - ADMINISTRATION and LOGISTICS

Location of control, command & support facilities	
Ground support, Catering & Medical Assistance	
T-Cards, Logs & Diaries, Record Keeping	
Finance and Accounting requirements	

C- COMMAND and COMMUNICATIONS

Incident Management Structure	
Incident Status (Level 1,2 or 3)	
Communication Plan (who, when, why)	
Radio Channels / Equipment	
REPORTING: - To whom - By whom - When - Detail required e.g. sitrep proforma - HOW (equipment, channels, No's)	

S- SAFETY

Injury / Near Miss	
Safety Issues	

BRIEFING SUMMARY

Ask questions to confirm understanding			
Issue supporting documents			
Summary			
Name	Date	Time	Sign.

Details of Group Being

Briefed:

To be Used by all briefing Officers at Sector, IMT and SCC / RCC levels.

To go to all incoming staff at Sector, Division, Division, IMT and SCC / RCC levels.

SOP 4.10: Aboriginal Cultural Heritage Act 1972 – Bushfire Incident

PURPOSE

To provide a standard process for Incident Controllers to follow in support of the *Aboriginal Cultural Heritage Act 1972*.

The *Aboriginal Cultural Heritage Act 1972* recognises, protects, conserves, and preserves Aboriginal cultural heritage (ACH) and recognises the fundamental importance of ACH to Aboriginal people and its role in Aboriginal communities past, present, and future. The ACH recognises the value of ACH to Aboriginal people as well as to the wider Western Australian community.

There is a legal requirement to avoid impacts to ACH. Until the amendments to the ACH Act 1972 are decided, due diligence must be exercised. This includes objects and places of importance or significance to Aboriginal people or connected with traditional cultural practises.

Mechanical works in areas that have not had ground disturbance in the past eg bush blocks / corridors must be checked to determine if ACH is in or around that location. The Incident Controller or nominated person must check the online “Directory for Aboriginal Heritage” to assess if Aboriginal Cultural Heritage is located in the activity area. The Directory can be found at the following web link:

<https://espatial.dplh.wa.gov.au/ACHIS/index.html?viewer=ACHIS>

The steps the Incident Controller has undertaken in the due diligence process need to be recorded including the basis for any decision that there isn’t a risk of harm to Aboriginal Cultural Heritage. This information is to be provided to the CESM as part of the incident report.

If Aboriginal Cultural Heritage is located in the area do not proceed with the activity of clearing breaks / felling trees and other activities that could disturb the area. Refer immediately to the CESM who will advise the CEO.

ELEVANT INFORMATION	
ADOPTED	NEW SOP – September 2023
REVIEWED	
SOP	SOP 4.01 Wildfire Operational Management SOP 4.02 Incident Control System – AIIMS SOP 4.08 Incident Escalations SOP 4.09 Transfer of Incident Control - Interagency
COUNCIL POLICY	
DELEGATION	
LEGISLATION	<i>Aboriginal and Cultural Heritage Act 1972</i>

SOP 4.11: Wind Farm Fire Fighting Procedures

PURPOSE

To provide a standard procedure for fighting fire in the Wind Farm area.

INTRODUCTION

The Flat Rocks Wind Farm Stage 1 has been constructed on privately owned land in the vicinity of Warrenup Rd in the western part of the Shire, and is operated by Enel Green Power. Stage 1 consists of 18 turbines, each standing at around 200 metres at the tip of the blade. The nacelle sits at the top of the tower and houses the generator.

A nacelle fire introduces a new fire dynamic to the area. The height of the turbine creates a potential for downwind spotting up to 5km downwind and can create dangerous conditions surrounding the base of the turbine.

Each turbine has its own heat monitoring and suppression system. If these are overwhelmed a nacelle fire is uncontrollable due to their height. A 30m Hazard Protection Zone has been established at the base of each turbine to protect it from being impacted by grass fires etc.

Within the area of the windfarm there are several dams that can be utilised for firefighting purposes, but these may not be a reliable source of water. Several strategically located water tanks are located within the windfarm to replenish firefighting water. The couplings to these tanks are 75mm male camlocks.

There are two types of fire that could impact the Wind Farm area. Following are the procedures that Enel Green Power has developed for each type of fire for their manager/staff and volunteer bushfire brigade members.

1. Nacelle Fire (fire in the turbine):

There is an automatic sprinkler system in each turbine to assist with suppression activities

Wind Farm staff response

- Report fire
- Shut down turbines, Y position and head to wind if possible
- Alert adjoining residents (SMS contact/WhatsApp)
- Alert the Shire/ Brigades for attendance

Landowner response

- Set up an exclusion zone no closer than 75 m from the base
- Provide the immediate suppression to the fire line outside the exclusion area
- Monitor the area downwind from the turbine for spot fires.
- Monitor the area until the nacelle fire is exhausted and an all clear has been given.

Brigade response

- Attend to the fire line outside the exclusion area.
- Alert areas down wind of the turbine, up to 5 km.
- Monitor for, and attend to, spot fires downwind from the turbine.

2. If a fire is approaching the site:

Wind Farm Staff response

- Shut down turbines, lock in Y position and head to wind if possible.
- Determine the severity of the fire by contacting the FCO / Incident Controller.

If there is potential for the fire to impact the site:

- If it is not safe to evacuate - workers at a turbine should park vehicles at the base of the turbine at the lee side of the approaching fire
- Guide personnel at risk to safety (evacuate or take shelter)
- All personnel not directly involved in the fire response are to evacuate the site to a safe location as directed by the management team in coordination with the Incident Controller for the fire.
- The Chief Warden (operations manager), and designated personnel, will ensure the evacuation of personnel has been successfully completed and that all personnel are accounted for.

Substation and Construction Compound

Fuel, oils and electrical hazards are located in these areas, bushfire brigade members are not to enter these areas/ compounds due to the dangers on site.

Flat Rocks Wind Farm Bush Fire Management Plan July 2022

The above document has been considered and approved by the Council.

RELEVANT INFORMATION	
ADOPTED	NEW SOP – September 2023
REVIEWED	
SOP	SOP 1.01 Communications Systems SOP 4.01 Wildfire Operational Management SOP 4.02 Incident Control System – AIIMS SOP 4.08 Incident Escalations
COUNCIL POLICY	2.2 Safety and Health in the Workplace
DELEGATION	
LEGISLATION	<i>State Planning Policy 3.7 Planning in Bushfire Prone Areas</i>

SOP 4.12: St John Ambulance Notification

PURPOSE

To ensure medical support is available to volunteer Bushfire Fighters in case of injury during a fire incident that is expected to be difficult to bring under control in a timely manner, and to ensure St John Ambulance have sufficient volunteers to maintain a response in case members are involved with the fire incident or roads are closed.

INTRODUCTION

St John Ambulance have asked through the Local Emergency Management Committee (LEMC) if they can be notified when Bushfire Brigades respond to a fire that is expected to be difficult to control. This could be due to weather conditions on the day, vegetation type or not having the resources available.

Most of the bushfire incidents in the area are brought under control in a relatively short period of time with mopping up being in most instances taking the longest time to complete.

PROCEDURE

If a fire incident is expected to be difficult to control the Incident Controller is to contact the CESM or the CEO and request that an SMS be circulated to the LEMC members (including St John representatives) to advise that there is a bushfire which has the potential to not be contained quickly. On receipt of this advice, St John Ambulance will be on standby in case of injury.

This will also allow St John Ambulance to determine their volunteer availability locally and whether assistance will be required from neighbouring Sub Centres.

RELEVANT INFORMATION	
ADOPTED	NEW SOP – September 2023
REVIEWED	
SOP	SOP 1.01 Communication Systems SOP 4.01 Wildfire Operational Management SOP 4.02 Incident Control System – AIIMS SOP 4.08 Incident Escalations
COUNCIL POLICY	2.2 Safety and Health in the Workplace
DELEGATION	
LEGISLATION	<i>Work Health & Safety Act 2020, Part 2, Division 3, s.22</i>

Section 5: Safety

DRAFT

SOP 5.01: Personal Protective Equipment

PURPOSE

To ensure a minimum standard of protective clothing is worn at all times on any fire ground.

INTRODUCTION

Personnel on the fire ground should be dressed in accordance with the minimum dress standard as specified below or equivalent. Personnel turning up to fires without the minimum requirement must be advised to dress properly or asked to leave the fire ground, or alternatively assigned a non-firefighting task.

PREFERRED STANDARD FOR BUSH FIRE FIGHTING

- Approved Proban-treated Overalls (one or two piece);
- Safety boots;
- Helmet; and
- Gloves, goggles, smoke mask or full face respirator.

Requests for PPE can be made at any time through the CESM. A bulk order is compiled in July each year for distribution prior to the fire season.

MINIMUM STANDARD FOR BUSH FIRE FIGHTING

- Cotton/woollen long trousers;
- Long sleeve shirt;
- Enclosed boots.
- Gloves, goggles, smoke mask or full face respirator.

GENERAL

- Depending on individual Brigade requirements, protective clothing may be kept in the Brigade's fire station, with appliances, or held by members as part of their individual firefighting kit. Protective clothing must be worn on any operational duty.
- All Brigade personnel are responsible for the availability, condition, care and cleanliness of their own kit.
- Only correctly attired personnel will be allowed to crew Brigade appliances.
- The appearance and conduct of the Shire's Bushfire Brigade members whilst wearing operational dress is to be such that will not cause any criticism upon the Shire of Broomehill-Tambellup.

RELEVANT INFORMATION	
ADOPTED	December 2008
REVIEWED	September 2023
SOP	SOP 1.03 Work Health & Safety – Incident/Injury/Hazard Reporting
COUNCIL POLICY	2.2 Safety & Health in the Workplace
LEGISLATION	<i>Work Health & Safety Act 2020, Part 2, Division 3, s.22</i> <i>Bush Fires Act 1954 s.36</i>

SOP 5.02: LACES

PURPOSE

These procedures are designed to minimise the risks associated with operational bush firefighting. Crew safety at bushfires is underpinned by a developed knowledge and experience of bush fire behaviour, situational awareness and the application of safety procedures. The acronym LACES provides a prompt to recall the steps required.

INTRODUCTION

All emergency services personnel are responsible for their own safety and the safety of others at an incident. The IC has ultimate responsibility to ensure the implementation of safe working practices at an incident.

The Strategic Control Priorities outlined within State Hazard Plan – FIRE make clear that:

“Protection and Preservation of Life: This is the fundamental overarching priority for the State, and includes:

- *Safety of emergency services personnel.*
- *Safety of community members including vulnerable community members and visitors/tourists located within the incident area.”*

PROCEDURE

During bushfire operations, there is a requirement to continuously reassess the changing dynamics of the fire to ensure a safer working environment for all. All personnel are to utilise **LACES** to plan their safety at incidents. The concept of LACES with detailed descriptions and tasking for each component is in the attached Appendix 5.

RELEVANT INFORMATION	
ADOPTED	October 2021
REVIEWED	September 2023
SOP	SOP 1.03 Work Health & Safety – Incident/Injury/Hazard Reporting
COUNCIL POLICY	2.2 Safety & Health in the Workplace
LEGISLATION	<i>Work Health & Safety Act 2020, Part 2, Division 3, s.22</i>

Appendix 6 – LACES

Use of LACES. LACES are to be implemented and utilised as a procedure at all bushfire incidents. OIC of appliances and crew are responsible for implementing and maintaining LACES. **Although individual parts of LACES can be tasked, all emergency services personnel should take an active role in maintaining LACES.**

Control	Description	Tasks
Lookouts	The establishment of lookouts at a bushfire is vital. Lookouts maintain awareness of the environment immediately surrounding personnel.	<ul style="list-style-type: none"> • Monitor the immediate surroundings of the crew • Look for potential hazards • Observe current weather • Look for changes in weather (wind strength, direction) • Monitor fire behavior • Monitor vehicle movements • Maintain line of sight with crew/personnel • Signs of fatigue
Awareness	Awareness is the responsibility of all personnel. OIC (and crew leaders) are responsible for ensuring common operating picture between personnel.	<ul style="list-style-type: none"> • Remain aware of the fire situation including (Current and potential weather, Terrain and aspect, fuel types and fuel loads, hazards, crew locations) • Be alert and act decisively before situations become critical. • Consider welfare and fatigue management and requirements
Communications	OIC (and crew leaders) are responsible for establishing and maintaining effective communications. It is not acceptable for personnel to be without communications at any time at a bushfire.	<ul style="list-style-type: none"> • Receive a pre-deployment briefing from the IC (preferably SMEACS) • On arrival at the fireground establish radio communications • Maintain radio communications by ensuring planned regular communications within the chain of command • Ensure that visual and/or verbal communications are maintained between crew. • Immediately communicate any changes in situation
Escape Routes	OIC (and crew leaders) are responsible for identifying and communicating to crew a minimum of 2 suitable escape routes.	<p><u>Locating Suitable escape routes that include:</u></p> <ul style="list-style-type: none"> • Containment lines of appropriate width • Firebreaks • Roads (sealed or unsealed) <p><u>OIC are to ensure all personnel:</u></p> <ul style="list-style-type: none"> • Know their escape route at all times • Ensure vehicles are positioned to allow for rapid escape
Safety Zones	A safety zone is an area cleared of flammable material and large enough to provide adequate space for crew protection.	<ul style="list-style-type: none"> • Safety zones must be monitored by OIC to ensure they remain suitable for use • All personnel must be aware of the location of established safety zones. • OIC are to ensure that an appropriate safety zone is identified and accessible to crews at all times at a bushfire.

SOP 5.03: Drugs and Alcohol

PURPOSE

To provide a standard procedure to manage drug and alcohol related incidents within the Shire's Bush Fire Brigades.

INTRODUCTION

Any accident that occurs where it is found that a firefighter has been taking illicit drugs and/or alcohol has implications not only for the individual but also the Shire. Some implications that could occur are:

- Insurance cover could be denied.
- Civil action could be taken if other firefighters are injured whilst under that individuals care (as driver, member of a team or managing an incident).
- Compromise your position within the Shire's Brigade.
- Compromise the Shire because they allowed you to represent them whilst you were under the influence of illicit drugs or alcohol (knowingly or unknowingly).

In addition to the Shire having a responsibility to look after the safety and welfare of the volunteer under the *Work Health & Safety Act 2020* and *Work Health & Safety (General) Regulations 2022*, the individual also has a responsibility to look after their own well-being.

PROCEDURE

Since drugs and alcohol have the ability to impair the judgment and reactions of an individual and firefighters invariably put themselves in positions of accepted risk, it is essential that 'acceptable risk' does not become an 'unacceptable risk'. The following procedure must be complied with to ensure that firefighters do not compromise their individual right to work in the safest environment possible.

- **Illicit Drugs**

Firefighters shall not respond to any incident or participate in any training activities associated with operational tasks where illicit drugs have been taken.

If a firefighter or officer is aware that another firefighter or officer is taking illicit drugs, appropriate action should be taken to remove that person from firefighting duties.

- **Alcohol**

Firefighters shall not respond to any incident or participate in any training activities associated with operational tasks where alcohol has been consumed.

Consumption of alcohol during or prior to commencing firefighting duties is not acceptable. It is inappropriate for any person to put another person at risk as a result of impaired judgment or reactions attributable to the consumption of alcohol.

It is unacceptable to allow firefighters to undertake an active firefighting role at an incident knowing they have consumed alcohol.

- **Prescribed Drugs**

If an individual is taking prescribed drugs that make them drowsy or functionally impaired, they must:

- Not take part in firefighting duties at an incident.
- Not take part in operational training activities.
- Notify the Incident Controller of the effects
- Take responsibility for their own safety and welfare and not compromise safety and welfare of others.

RELEVANT INFORMATION	
ADOPTED	December 2008
REVIEWED	September 2023
SOP	SOP 1.03 Work Health & Safety – Incident/Injury/Hazard Reporting
COUNCIL POLICY	2.2 Safety & Health in the Workplace
LEGISLATION	<i>Work Health & Safety Act 2020, Part 2, Division 3, s.22</i>

SOP 5.04: Drip Torches

PURPOSE

To provide a standard procedure to manage the safe use and maintenance of a drip torch.

INTRODUCTION

The drip torch is to be used for prescribed burning and authorised lighting activities only. The drip torch is a container holding a fuel mixture that drips from a nozzle over a lighted wick, dripping burning liquid onto the fuel to be ignited.

PROCEDURE

When preparing to use the drip torch, the operator should:

- Ensure that there is no risk to other personnel in the vicinity.
- Use the torch on the designated burn area only.
- Wear the correct personal protective equipment, including gloves and goggles when filling, lighting, operating and extinguishing a drip torch.
- Start the torch and ignite vegetation and complete the burn under the direction of the officer in charge.
- When not in use, stand the torch upright and ensure that the flame is extinguished.
- When not in use, ensure that the torch is stored upright in a secure position.
- When not in use, ensure that the fuel tap is maintained in the closed position.
- Fuel for drip torches must be premixed at a location separate to any incident ground.
- Fuel for drip torches must be premixed in a recommended flammable liquid fuel container, stored away from the incident and clearly marked.
- Ensure regular maintenance is undertaken and report any defects.
- The fuel mixture is to be 25% Petrol and 75% Diesel as per manufacturer's instructions.

Only qualified and experienced firefighters should use the drip torch.

NOTE

All backburn operations must be authorised by the Incident Controller

The wick will remain hot for some time after it has been extinguished

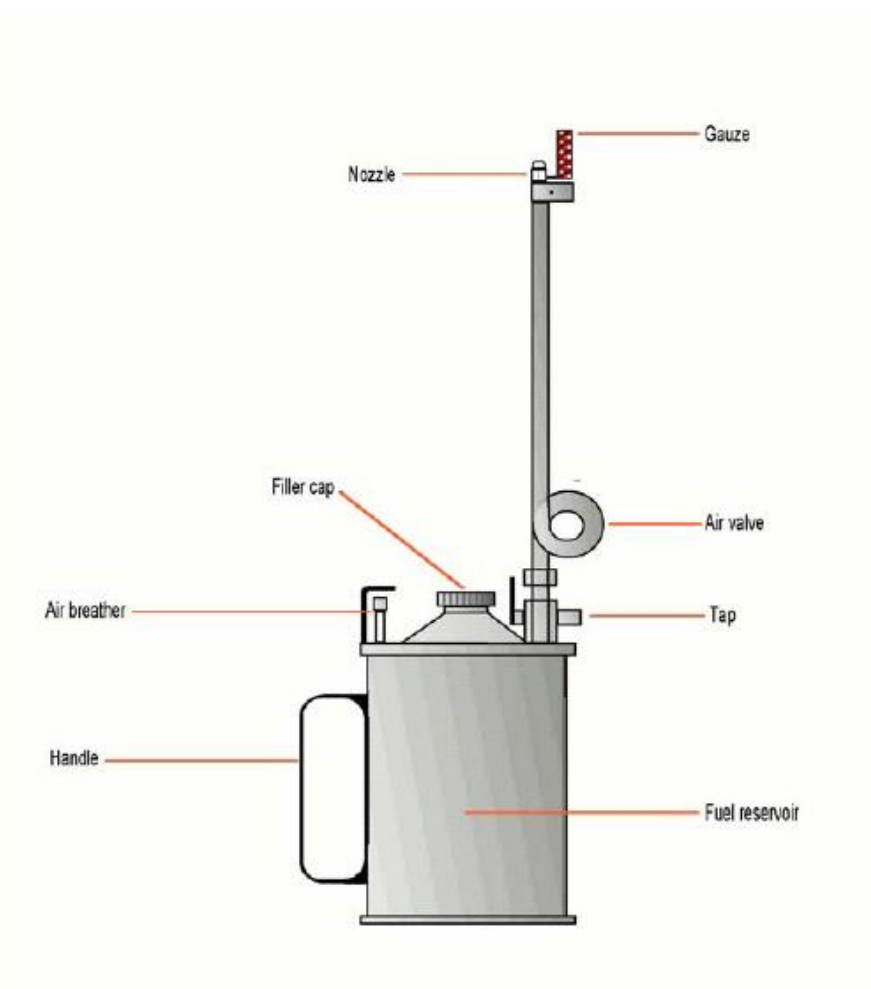

RELEVANT INFORMATION	
ADOPTED	December 2008
REVIEWED	September 2023
SOP	SOP 1.03 Work Health & Safety – Incident/Injury/Hazard Reporting SOP 5.01 Personal Protective Equipment
COUNCIL POLICY	2.2 Safety & Health in the Workplace
LEGISLATION	<i>Work Health & Safety Act 2020, Part 2, Division 3, s.22</i>

SOP 5.05: Driving Guidelines

PURPOSE

To ensure that formal brigade appliances are operated in a safe manner.

INTRODUCTION

Bush Fire Brigades have a high profile as an emergency service provider within the community. To maintain that high profile, personnel using vehicles must adhere to vehicle policy with a clear understanding of the guidelines.

It should be noted that exemptions from the Road Traffic Code 2000 apply to formal brigade appliances only.

EXEMPTION TO ROAD TRAFFIC CODE 2000

While travelling to and from a fire (on public roads), the Shire of Broomehill-Tambellup bush fire appliances should only carry personnel who are safely seated in the cab or on specially designed seating fitted with seat belts.

The drivers and passengers of firefighting appliances are legally exempt from the requirement of the Road Traffic Code 2000 to wear seat belts “when engaged in firefighting activity”. However for safety reasons it is strongly recommended that drivers and passengers in the Shire of Broomehill-Tambellup fire appliances wear available seat belts wherever possible.

An exemption to the Road Traffic Code 2000 exists which allows personnel to travel in the load space of a private fire fighting vehicle when ‘engaged in firefighting activity on the fire ground’. This exemption **does not apply** when travelling to and from the fire scene. All firefighting personnel in private fire units should travel to and from the fire ground in the cab of the vehicle wearing seatbelts where provided.

GUIDELINES

- All drivers must hold a current and appropriate class of driving license necessary for the appliance being driven.
- A register of Drivers’ Licenses shall be maintained for all Shire volunteers driving Shire-owned emergency vehicles.
- Drivers holding “P” Plates may drive appliances as part of Driver Training; however, they are not to drive to or at emergency/incidents.
- Drivers are not to operate any fire appliance for longer than a 12-hour shift.
- Drivers are not to exceed 20km over the allocated speed limit of the road on which the vehicle is travelling.

CODE 1

Unit to respond with due haste - life/property in immediate danger.

1. Emergency Warning Lights at all times during travel and operation at incident.
2. SIREN (if fitted to vehicle) to be used during travel to incident as appropriate.
3. ALL speed signs of the Road Traffic Act to be obeyed.

4. ALL Traffic Lights and Road Traffic Signals/Signs to be obeyed unless the driver of the Fire Appliance is confident that it is safe and expedient to “contravene” and that all other traffic will give way to the fire appliance.
5. Rail crossing signals and boom gates to be obeyed at ALL times.

CODE 2

When returning to fire station, attending training or exercises and general operations:-

1. NO emergency warning lights or sirens are to be used.
2. ALL Road Traffic Codes to be complied with.

DRIVING REQUIREMENTS FOR OFF-ROAD USE

1. Minimum speed to be used to ensure safety of occupants.
2. Exhaust brake where fitted to be engaged at all times.

GENERAL

1. Bush Fire Fighters must at all times, drive with due care and attention and continue to show consideration to other road users.
2. It is essential that the privileges granted by law are not abused.
3. Crew care and safety must be of paramount importance at all times when driving fire appliances.
4. Warning Lights to be in operation at all times when brigade personnel are working off the appliance as other vehicle movement may prove a hazard.
5. Smoke hazard signs to be installed on roads where Bush Fire Brigades are operating.
6. In order to improve visibility of fire appliances to each other during fires it is recommended that emergency lights & headlights be used.

RELEVANT INFORMATION	
ADOPTED	December 2008
REVIEWED	September 2023
SOP	SOP 1.03 Work Health & Safety – Incident/Injury/Hazard Reporting SOP 3.01 Incident Announcement SOP 3.02 Fire Appliances Outside Municipality Boundaries SOP 4.01 Wildfire Operational Management
COUNCIL POLICY	2.2 Safety & Health in the Workplace
LEGISLATION	<i>Road Traffic Code 2000 Part 19 Div. 1</i> <i>Work Health & Safety Act 2020, Part 2, Division 3, s.22</i>

SOP 5.06: Electrical Hazards

PURPOSE

To provide personnel with a standard and safe procedure for incidents where electricity may be hazardous to personnel, casualties and/or bystanders.

INTRODUCTION

Electricity is a major hazard to firefighters, as it will be encountered at many structural fires and bush fires. All precautions at any incident where electrical hazards exist must be taken.

PROCEDURE

- Identify any electrical hazards that are present.
- Keep personnel and members of the public away from electrical hazards.
- Determine a safe distance from the electrical hazard.
- Electricity should always be disconnected:
 - When the situation is unknown.
 - At any time that water is to be applied within a structure.
 - At any time firefighters are at risk.
 - On adjacent buildings if it is reasonably expected that the fire may impinge on them.

STRUCTURAL FIRES (DEFENSIVE FIREFIGHTING ONLY)

If the electricity is to be disconnected, it is the responsibility of the Incident Controller to check that power is switched off at the main board and that the fuses have been removed (where possible).

When disconnecting the power supply:

- The switch is to be operated with the back of the hand at arm's length.
- The head is to be turned away to avoid possible flash injuries.

240 VOLT POWER GENERATED BY SOLAR PANELS

All Emergency Service responders should be aware that if attending an incident at a property that has Solar Panels installed, there is the potential for live 240v power to be circulating through the property even though the mains switchboard has been isolated and fuses removed.

The following procedure is recommended for isolating power at properties with solar panels installed:

- Switch off the main isolating switch and all circuit breakers and remove all fuses at the main switchboard. Also check to see if there is an inverter isolator switch for the solar panel system; if not,
- Inspect the property to see if any solar panels and / or backup generators are installed on the property (should be visible and near to main property).
- Seek local knowledge and obtain advice on where the system may be isolated.
- If local knowledge is not available, locate the inverter/generator main switch or change over switch and isolate by turning off (this switch is usually at the main switchboard).
- Wait for further support from experienced personnel.

POWER LINES/POLE TOP FIRES

The Incident Controller is to brief all incoming crews on the possibility of live power being present at an incident.

Do not park appliances or position equipment beneath overhead power lines.

Where wires have made contact with the ground treat all wires as being live and maintain a 10m safe distance from the wires.

Locate wire ends to ensure source is not being transferred through another conductor e.g. steel fence, vehicle, etc.

All personnel are to avoid direct and water contact with wires and infrastructure until it has been confirmed the power is off.

Contact DFES Comcen on 1800 198 140 or 000 with the information listed below. This information will be passed by DFES directly to the Western Power Communication Centre for action, such as isolating the power supply to the area.

Wait for the arrival of Western Power personnel.

Information Required	Details
Contact Person and Phone Number	<i>Name of person reporting:</i>
Phone No:	
Contact at scene:	
Phone No:	
Issue of Concern	<i>i.e. Pole top fire, powerlines on ground etc.</i>
Pole Identification Number	<i>Nearest Pole No. found on plate or triangle.</i>
Pole Location	<i>Nearest road, locality or property number.</i>
Requested Action	<i>i.e. crew required, disconnect power etc.</i>

Note: This procedure is for the use of emergency services only. General faults should be directed to the Western Power Fault Number 131 351

RELEVANT INFORMATION	
ADOPTED	December 2008
REVIEWED	September 2023
SOP	SOP 1.03 Work Health & Safety – Incident/Injury/Hazard Reporting
COUNCIL POLICY	2.2 Safety & Health in the Workplace
LEGISLATION	<i>Work Health & Safety Act 2020, Part 2, Division 3, s.22`</i>

SOP 5.07: Burnover Blankets

PURPOSE

To provide a standard procedure for firefighters in the use of burnover blankets.

INTRODUCTION

Burnover blankets are a piece of equipment for protecting firefighters out on the fireline. The blankets are made from a light weight, patented material and are 2m x 2m in size. Installation of burnover blankets in all Local Government and DFES appliances has been undertaken in accordance with directive. Volunteers are to be trained in burnover blanket entrapment procedures.

PROCEDURE

- Ensure LACES is implemented at all times:
 - L – Lookouts
 - A – Awareness
 - C – Communication
 - E – Escape Routes
 - S – Safety Zones
- Locate the burnover blanket in the appliance. The burnover blankets are housed in a red protective sleeve or bag in a fixed position appropriate to the appliance and must not be relocated.
- Obtain the burnover blanket from its storage bag by lifting the flap and remove the vacuum packed blanket.
- Open the plastic wrapping by tearing from the top then expanding the tear so the blanket can be removed easily.
- Straight pull towards you to start with, and then rip sideways.
- Remove the burnover blanket from the plastic cover.
- Unfold the burnover blanket fully and cover yourself completely.
- Remain covered and get below the window level of the appliance until the fire has passed.
- After the burnover, conduct post-burnover procedures.
- Used burnover blankets should be left with the vehicle for examination in any investigation that may follow.
- Do not attempt to replace or reuse the used burnover blanket.
- Know the location of the burnover blankets in your appliance or vehicle.

RELEVANT INFORMATION	
ADOPTED	August 2014
REVIEWED	September 2023
SOP	SOP 1.03 Work Health & Safety – Incident/Injury/Hazard Reporting
COUNCIL POLICY	2.2 Safety & Health in the Workplace
LEGISLATION	<i>Work Health & Safety Act 2020, Part 2, Division 3, s.22</i>

SOP 5.08: Chainsaws

INTRODUCTION

When responding to bushfires fire fighters may encounter trees that need felling or a situation where it is advantageous to clear a track of fallen timber. On occasions chainsaws have been used to undertake these tasks.

Changes to legislative requirements and the increased need for specific training on all items of equipment means that the ongoing use of chainsaws by untrained personnel is in breach of these legislative requirements.

In recognising the risks associated with chainsaw use neither DFES nor the Shire of Broomehill-Tambellup provide them as standard stowage items on fire appliances. Notwithstanding this, it is acknowledged that crews who have assisted at incidents outside the Shire have been in situations where a chainsaw has been required to preserve crew safety. For incidents outside the Shire, approval may be granted for a crew to obtain a chainsaw from the Shire, to be collected prior to mobilisation.

Tree Felling

The felling of trees with a chainsaw by a Brigade member is **strictly prohibited**. Where it is necessary to fell a tree, earthmoving equipment or suitably qualified operators, as approved by the Incident Controller or the CESM, must be used.

Clearing Fallen Timber

Brigade members who hold an appropriate chainsaw operator certificate, can only use a chainsaw to clear fallen timber in an emergency situation (e.g. blocked emergency egress route, vehicle or personnel entrapment, etc.) At all other times earthmoving machinery or approved operators shall be used.

Minimum Training Qualification

Brigade members intending to use a chainsaw on a fire ground must hold an appropriate qualification confirming competency as issued by TAFE or other recognised institution. Copies of the certificate (including refresher certificates) must be provided to the Shire prior to each fire season.

Directions for Use

- Chainsaws may only be used with the prior approval of the Incident Controller or CESM.
- All chainsaw operators must wear full personal protective equipment: chaps, steel boots, gloves, goggles, hearing protection and helmet.
- All chainsaw operators must be accompanied by a spotter at all times.

RELEVANT INFORMATION	
ADOPTED	December 2020
REVIEWED	September 2023
SOP	SOP 1.03 Work Health & Safety – Incident/Injury/Hazard Reporting
COUNCIL POLICY	2.2 Safety & Health in the Workplace
LEGISLATION	<i>Work Health & Safety Act 2020, Part 2, Division 3, s.22</i>

DRAFT

SOP 5.09: Refilling Motors at Fire Incidents

Introduction

Storing fuel in metal fuel containers is a common practice on all firefighting appliances as it allows additional reserves of ULP and/or drip torch fuel to be readily available.

If a fuel container is exposed to high temperatures, a build-up of pressure inside the fuel container will occur. Upon opening this pressure build up can cause a sudden and vigorous expulsion of fuel vapour.

There have been instances of firefighting personnel being doused in flammable liquid when opening fuel containers. The fuel ignited and caused burns to the fire fighters. Therefore, personnel opening a fuel container must follow the recommended DFES 'six step process'.

General

In order to minimise the risks associated with refuelling pump motors, refuelling will only occur when the vehicle is in a safe area (e.g. a water point, staging area, well-ventilated area, cold zone).

The greatest risk of injury caused by pressurised fuel occurs when the fuel can is being opened. Ensure minimum PPE is worn and fuel can is opened in an area completely free of any potential ignition sources.

This procedure is to be followed for refuelling of all static motors on all vehicles where fuel cans are utilised as the refuelling method:

- Move vehicle to a clear area (e.g. off the fire ground)
- Ensure pump engine is not running.
- Remove the fuel can from the vehicle.
- Ensure minimum PPE is worn.
- Ensure a 5m radius safe zone free of ignition sources (including the vehicle) and other personnel.
- Follow correct fuel can opening technique:
 - Kneel behind the fuel can with cap facing away from the body.
 - Fully withdraw the retaining pin.
 - Lift cap handle slowly to allow pressure build up to vent, with any venting away from the body.
 - Control opening with hand pressure as required.
 - Lift cap handle completely once venting has ceased.
- Prior to pouring fuel from the fuel can into the pump engine fuel tank ensure that your feet are on the ground, you earth yourself by touching the appliance, and the pouring funnel is in contact with the fuel tank. This will reduce the potential for ignition due to static.
- Always clean off excess fuel from the tank with a rag.
- Do not re-enter the fire ground if PPE has been splashed with fuel (find alternate PPE).

Filling Fuel Containers

Fuel cans on vehicles or held at stations/units must not be overfilled. Fuel vapours will expand when exposed to heat and an expansion chamber for the vapours must be maintained. Fuel cans should only be filled to a maximum of 80% of total capacity. The easiest way to ensure the fuel can is not overfilled is at the petrol bowser, i.e. only put 4L into a 5L fuel can, or 16L into a 20L fuel can.

RELEVANT INFORMATION	
ADOPTED	December 2020
REVIEWED	September 2023
SOP	SOP 1.03 Work Health & Safety – Incident/Injury/Hazard Reporting
COUNCIL POLICY	2.2 Safety & Health in the Workplace
LEGISLATION	<i>Work Health & Safety Act 2020, Part 2, Division 3, s.22</i>

DRAFT

Section 6: Equipment Management

DRAFT

SOP 6.01: Fire Appliances – Maintenance and Modification

PURPOSE

To ensure that all Shire appliances and equipment is maintained in faultless condition.

INTRODUCTION

As emergency appliances and equipment is predominantly used in hazardous and high-pressure situations, it is essential that the reliability and integrity of both is maintained to a high standard so as not to place any firefighter in danger due to equipment failure.

OPERATING LEVEL MAINTENANCE

Broomehill Central Brigade members are responsible for the Operating Level Maintenance of the Shire owned fire appliance. In this context Operating Level Maintenance includes:

- Checking vehicle tyre pressures.
- Checking & replenishing radiator fluid levels for the vehicle engine and pump motor (where fitted).
- Checking & replenishing lubricant levels on the vehicle and pump engines.
- Checking & replenishing brake & clutch master cylinder fluid levels.
- Checking & replenishing windscreen washer fluid.
- Checking the operation of all vehicle lights, emergency lights & sirens.
- Checking the operation of the WAERN Bushfire Radio including external speaker (where fitted).
- Testing Automatic Vehicle Locator (AVL) – *see SOP 6.02*
- Checking & replenishing battery electrolyte levels.
- Cleaning of vehicles.
- Checking the presence of all appliance stowage & its serviceability.
- Checking the operation of fire pumps, valves, sprays, nozzles & hose reels.
- Reporting any defective or unserviceable appliance items to the Brigade FCO.
- Check burnover blankets are available and stowed properly.
- Checking Water Deluge System.
- Checking the condition and stowage of the In Cab Air.

The brigade appliance in Tambellup is owned by DFES and the responsibility for these checks lies with the Tambellup Volunteer Emergency Service Unit.

FAST FILL TRAILERS

Each brigade has been equipped with a fast fill trailer including pump and appropriate hoses and fittings. Fast fill trailers are housed at agreed locations within the brigade area.

Registration and insurance of each trailer is the responsibility of the Shire. It is the responsibility of each brigade to ensure that trailers remain roadworthy and pumps/fittings are operational. If repairs or consumables are required the CESM should be notified.

DEPOT LEVEL MAINTENANCE

All major servicing and maintenance of the Broomehill Central Fire Truck is the responsibility of the Shire. During this inspection assessments will be made on any future remedial maintenance for the fire appliances.

All servicing and maintenance of vehicles associated with the Tambellup Volunteer Emergency Service Unit is the responsibility of the VFES members and DFES.

MODIFICATIONS TO FIRE APPLIANCES

Brigades should not undertake the modification of the Shire's Fire Appliances, without the express permission of the Shire of Broomehill-Tambellup. Contravention of this policy could jeopardise insurance coverage or be in breach of Grant Agreement undertakings made through the Local Government Grant Scheme.

RELEVANT INFORMATION	
ADOPTED	December 2008
REVIEWED	September 2023
SOP	SOP 6.02 Automatic Vehicle Locator - AVL
COUNCIL POLICY	Nil
LEGISLATION	<i>Bush Fires Act 1954 s.36</i>

SOP 6.02: Automatic Vehicle Locator - AVL

PURPOSE

These procedures include an overview of the AVL system and how to update the system. The Broomehill Central Volunteer Bushfire Brigade appliance is fitted with an AVL, with the CESM managing 2 portable units for the Shire.

The Tambellup VFES appliance is also fitted with an AVL – responsibility for management lies with Unit members in conjunction with DFES.

INTRODUCTION

The AVL System provides real-time visibility of appliances especially during large scale bushfires and provides automatic features to support crew safety. The AVL system also includes an emergency distress button to be used in emergency situations. When activated it sends an alarm to the DFES Communications Centre. The system records vehicle location, speed, and if lights and sirens have or are being activated. DFES Officers, CESM's and authorised brigade members have access to the link to track appliance locations across the State.



PROCEDURE

Activation in an emergency situation: Under normal conditions the light will be showing green.

To activate the emergency button HOLD IT DOWN FOR 4 SECONDS - the green light will turn red until DFES Communications has acknowledged, then the light will show green again. Once activated DFES Communications will contact the Incident Controller for that fire, the Duty Officer for the region or the Community Emergency Services Manager to follow up.

Testing of the AVL:

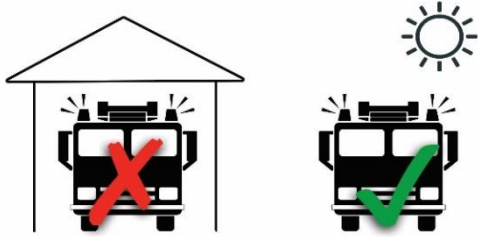
- Testing of the AVL system is to be carried out on a **MONTHLY** basis to keep the system updated with new software. See diagram below on how to test the system.
- The system is connected to the 3G network and if this is not available the system will link to the satellite.
- If for any reason the button is accidentally activated and the light stays solid red (not flashing) ring DFES Communications on 1800 198 140 to notify them of the mistake.
- Refer to Operational Brochure and general information sheet that is located in the Broomehill Central Bushfire appliance for further information.
- Any issues with the system please contact the CESM to follow up.

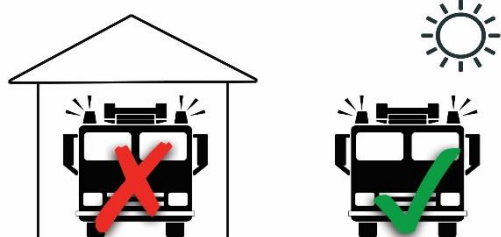
STEP	PROCESS
1	<p>Make sure your vehicle is parked outside the shed or situated in the open.</p> 
2	<p>The Emergency Duress Button must be showing a solid green light (not flashing) to indicate AVL unit is in NextG Mobile Phone coverage before the unit can commence test mode.</p> 
3	<p>Push the Emergency Duress Button 4 times in quick concessions within 4 seconds (1 push per 1 second)</p>  <p>The Emergency Duress Button will start flashing green and red lights to indicate the unit is in test mode. Once testing is complete the Emergency Duress Button will return to a solid green light.</p>
4	<p>Leave the vehicle parked outside the shed or situated in the open for another 30 minutes before returning it back into the shed. This is to facilitate any software updates required for the AVL unit – it is important the vehicle battery remains un-isolated.</p> 

RELEVANT INFORMATION	
ADOPTED	December 2017
REVIEWED	September 2023
SOP	SOP 1.03 Work Health & Safety – Incident/Injury/Hazard Reporting SOP 6.01 Fire Appliances – Maintenance and Modification
COUNCIL POLICY	2.2 Safety & Health in the Workplace
LEGISLATION	<i>Bush Fires Act 1954 s.36</i> <i>Work Health & Safety Act 2020, Part 2, Division 3, s.22</i>

DRAFT

7. MATTERS FOR DISCUSSION/INFORMATION

Nil.

8. GENERAL BUSINESS

Kim Oliver

Permits to do Protective Burning

- Currently permits to burn issued during the Restricted Burning period require a buffer of two days of Moderate Fire Danger Rating (FDR) if a High FDR is forecast.
- While last fire season was quite mild, there is every chance that this season will see more consecutive High FDR days that will not allow the buffer to be achieved, resulting in less burning time.
- It is considered the current arrangements are too restrictive and may result in a reduction in protective burning being completed.
- Requested consideration of reducing the two day Moderate FDR requirement, to allow protective burning to be undertaken up to midnight before the day of the High FDR. In this situation, burning of timber or chaff piles are not to be authorised, and the Fire Behaviour Index (FBI) for the day of High FDR should not exceed 35.

Recommendation/Committee Decision

Moved Kim Oliver, seconded Laurie Hull

That during the Restricted Burning period 14 March to 15 April:

- a. Permits to burn (not including timber or chaff piles) may be issued with burns to be completed up to midnight on the day before the day of a HIGH Fire Danger Rating with a Fire Behaviour Index not exceeding 35;
- b. Permits issued for days with HIGH Fire Danger Rating and a Fire Behaviour Index exceeding 35 will not be valid in accordance with existing procedures;
- c. All permits are suspended for the two days prior to a forecast EXTREME or CATASTROPHIC day.

CARRIED

Recommendation/Committee Decision

Moved Kim Oliver, seconded Rhys Brown

That during the period 1 October to 30 November, permits to burn may be issued for protective burning to be completed in accordance with the Fire Break Order. Additionally, burns may be conducted on days with a HIGH Fire Danger Rating and Fire Behaviour Index not exceeding 35, between the hours of 6pm -12 midnight of the same day, at the discretion of the Gazetted Fire Weather Officer.

CARRIED

The above recommendations will be included in *Standard Operating Procedure 1.2 Permits to Set Fire to the Bush* for the Council's consideration.

Carl Letter:

- are the radio channel cheat sheets for neighbouring Shires still available? Cindy to follow up.
- Also – the change to the Restricted Burning period commencement date to 1 October was a great move.

9. NEXT MEETING AND CLOSE

The next meeting is scheduled for March 2024, with the date to be determined. There being no further discussion, the Chair thanked everyone for their attendance and declared the meeting closed at 7.49pm.